

# 屋内照明器具特性

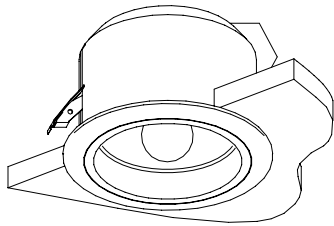

品名	DE-2672		
光源	KR100V54W-W		
光束	810 Lm	灯数	1 灯



配光曲線図

cd/1000lm

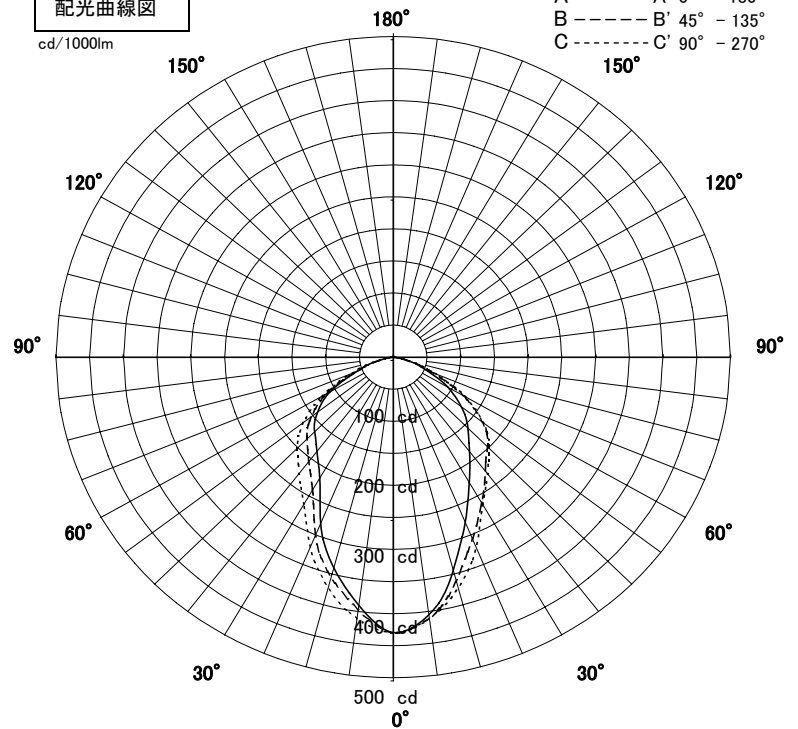

1/2照度角

直射水平面照度

単位:Lx

器具効率	79.8	%
上方効率	0.0	%
下方効率	79.8	%
保守率	良	0.84
	中	0.79
	否	0.7
1/2照度角		
A-A'	46.0	H
B-B'	52.0	H
最大取付間隔		
A-A'	0.85	H
B-B'	0.98	H

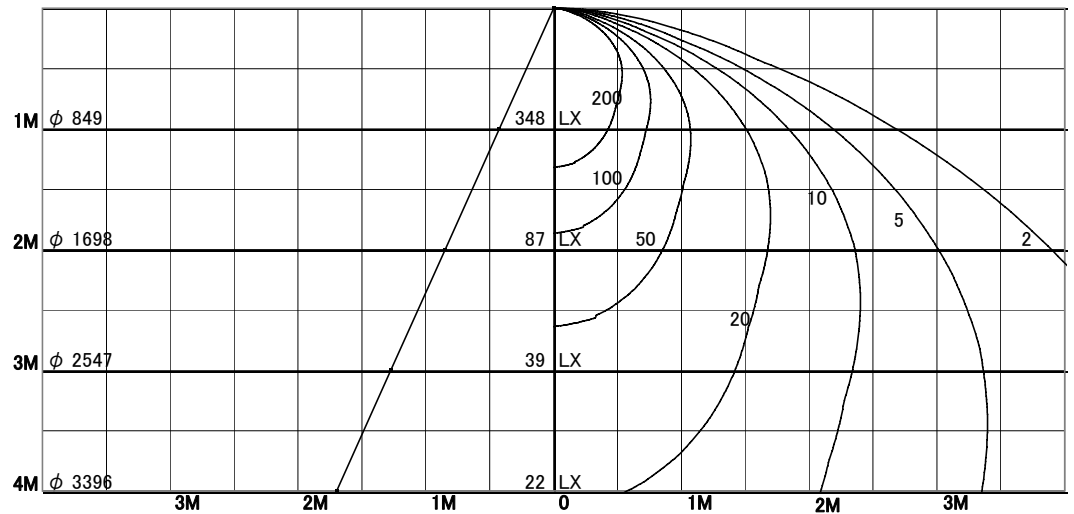

照明率表

天井	80%				70%				50%				30%				0%
	70%	50%	30%	10%	70%	50%	30%	10%	70%	50%	30%	10%	70%	50%	30%	10%	0%
壁	10%																0%
床	10%																0%
0.60	47	38	32	28	46	38	32	28	44	37	32	28	43	36	31	28	27
0.80	54	46	40	36	53	45	40	36	51	44	39	35	49	43	39	35	34
1.00	60	52	46	42	58	51	46	42	56	50	45	41	54	49	45	41	40
1.25	64	57	52	48	63	57	52	48	61	55	51	47	59	54	50	47	45
1.50	68	61	56	52	66	61	56	52	64	59	55	52	62	58	54	51	50
2.00	72	67	63	60	71	66	62	59	69	65	61	59	67	63	60	58	56
2.50	75	71	67	64	74	70	67	64	72	68	65	63	70	67	64	62	60
3.00	77	73	70	67	76	72	70	67	74	71	68	66	72	69	67	65	63
4.00	79	76	74	71	78	75	73	71	76	74	72	70	74	72	70	69	67
5.00	80	78	76	74	79	77	75	73	77	75	74	72	75	74	72	71	69
7.00	82	80	78	77	81	79	78	76	79	77	76	75	77	76	75	74	72
10.00	83	81	80	79	82	80	79	78	80	79	78	77	78	77	76	76	73

※(100V点灯時) 110Vまたは100/110V定格ランプの照度データは100V点灯時の値です。