

屋内照明器具特性

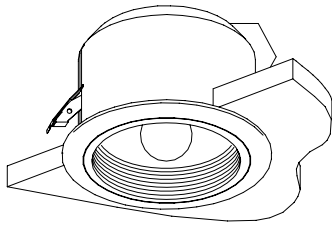

品名	DE-2673		
光源	KR100V54W-W		
光束	810 Lm	灯数	1 灯



配光曲線図

cd/1000lm

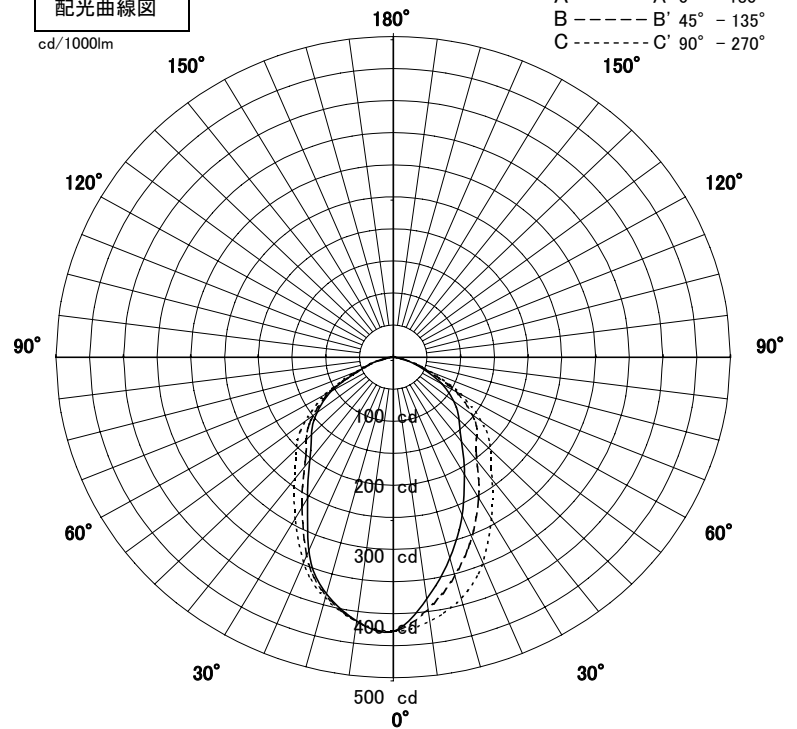

1/2照度角

直射水平面照度

単位:Lx

器具効率	78.9	%
上方効率	0.0	%
下方効率	78.9	%
保守率	良	0.84
	中	0.79
	否	0.7
1/2照度角		
A-A'	48.5	H
B-B'	55.5	H
最大取付間隔		
A-A'	0.90	H
B-B'	1.05	H

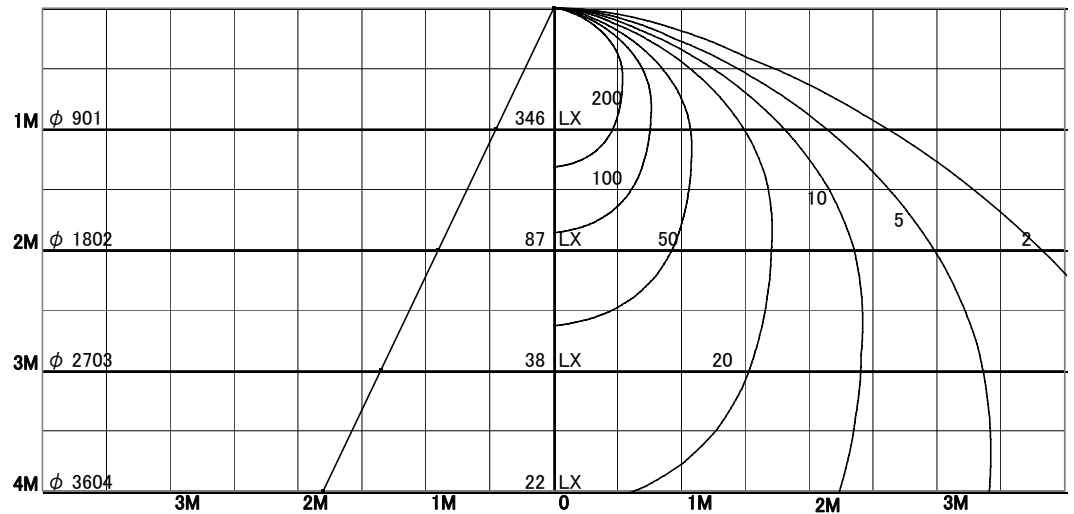

照明率表

天井	80%				70%				50%				30%				0%
	70%	50%	30%	10%	70%	50%	30%	10%	70%	50%	30%	10%	70%	50%	30%	10%	0%
壁	10%																0%
床	10%																0%
0.60	47	39	33	29	47	38	33	29	45	38	33	29	43	37	32	29	28
0.80	54	46	41	37	53	46	40	36	51	45	40	36	50	44	39	36	35
1.00	60	52	47	43	58	51	46	42	56	50	46	42	54	49	45	42	40
1.25	64	57	52	48	63	57	52	48	61	55	51	48	59	54	51	48	46
1.50	67	61	57	53	66	61	56	53	64	59	55	52	62	58	55	52	50
2.00	72	67	63	60	71	66	63	59	68	65	62	59	66	63	61	58	56
2.50	74	70	67	64	73	70	66	64	71	68	65	63	69	67	64	62	61
3.00	76	73	70	67	75	72	69	67	73	70	68	66	71	69	67	65	63
4.00	78	76	73	71	77	75	73	71	75	73	71	70	73	72	70	69	67
5.00	79	77	75	73	78	76	75	73	76	75	73	72	75	73	72	71	69
7.00	81	79	78	76	80	78	77	76	78	77	75	74	76	75	74	73	71
10.00	82	81	79	78	81	80	79	78	79	78	77	76	77	76	76	75	73

※(100V点灯時) 110Vまたは100/110V定格ランプの照度データは100V点灯時の値です。