

屋内照明器具特性

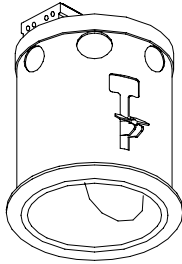

品名	DH-2985		
光源	CMH20/MR16/SP		
光束	850 Lm	灯数	1 灯



配光曲線図
実光度

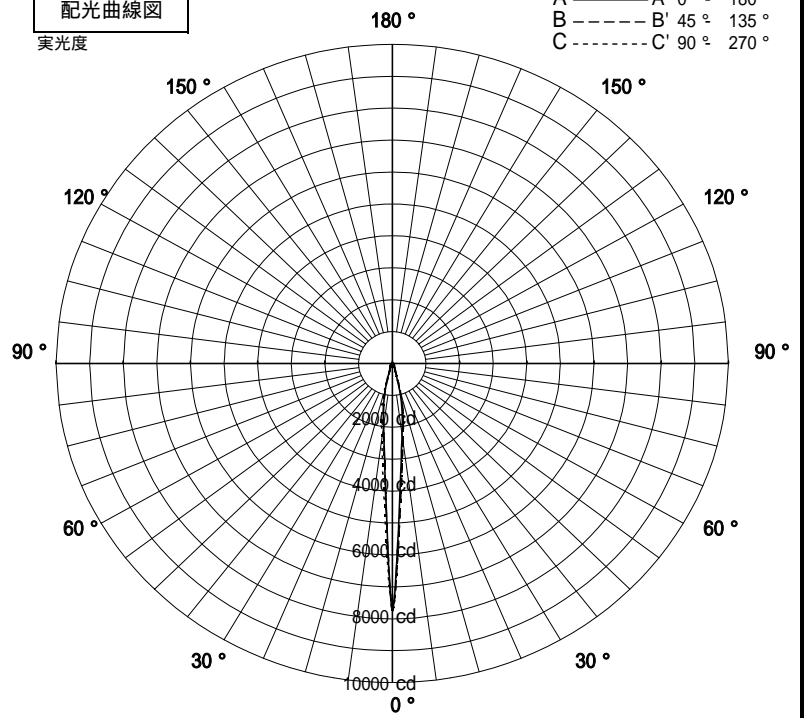

器具効率	87.0	%
上方効率	0.0	%
下方効率	87.0	%
保守率	良	0.65
	中	0.61
	否	0.54

1/2ビーム角		
A - A'	10.0	度
C - C'	15.0	度

A - A' Section

1/2ビーム角

C - C' Section

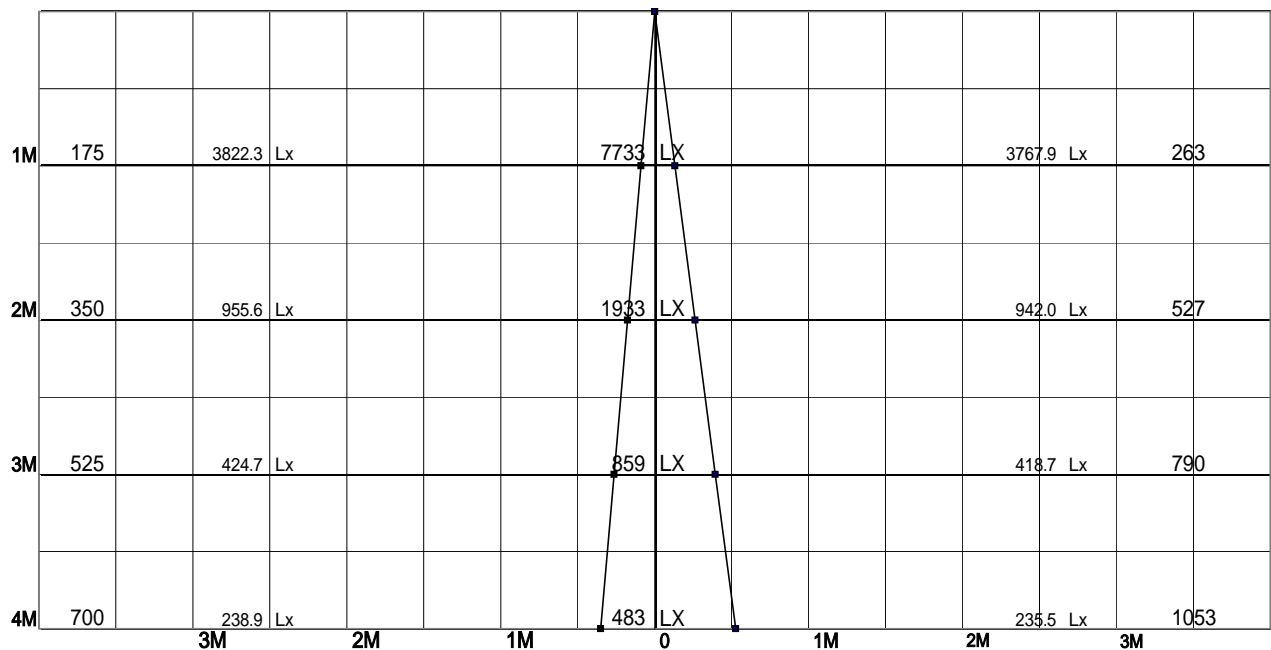

屋内照明器具特性



品名	DH-2985		
光源	CMH20/MR16/FL		
光束	720 Lm	灯数	1 灯

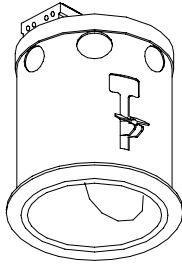

配光曲線図
実光度

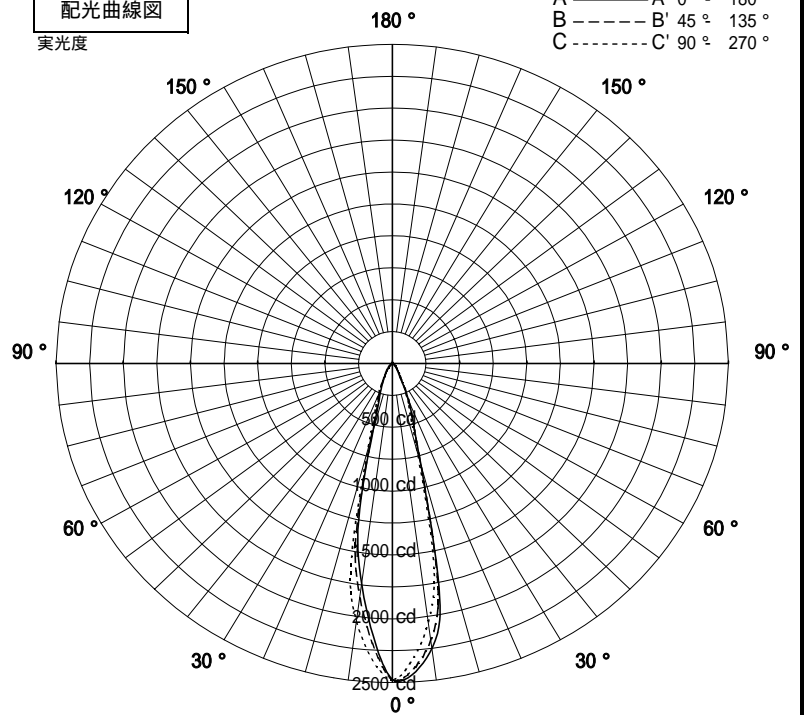

器具効率	86.9	%
上方効率	0.0	%
下方効率	86.9	%
保守率	良	0.65
	中	0.61
	否	0.54

1/2ビーム角		
A - A'	25.5	度
C - C'	25.5	度

A - A' Section

1/2ビーム角

C - C' Section

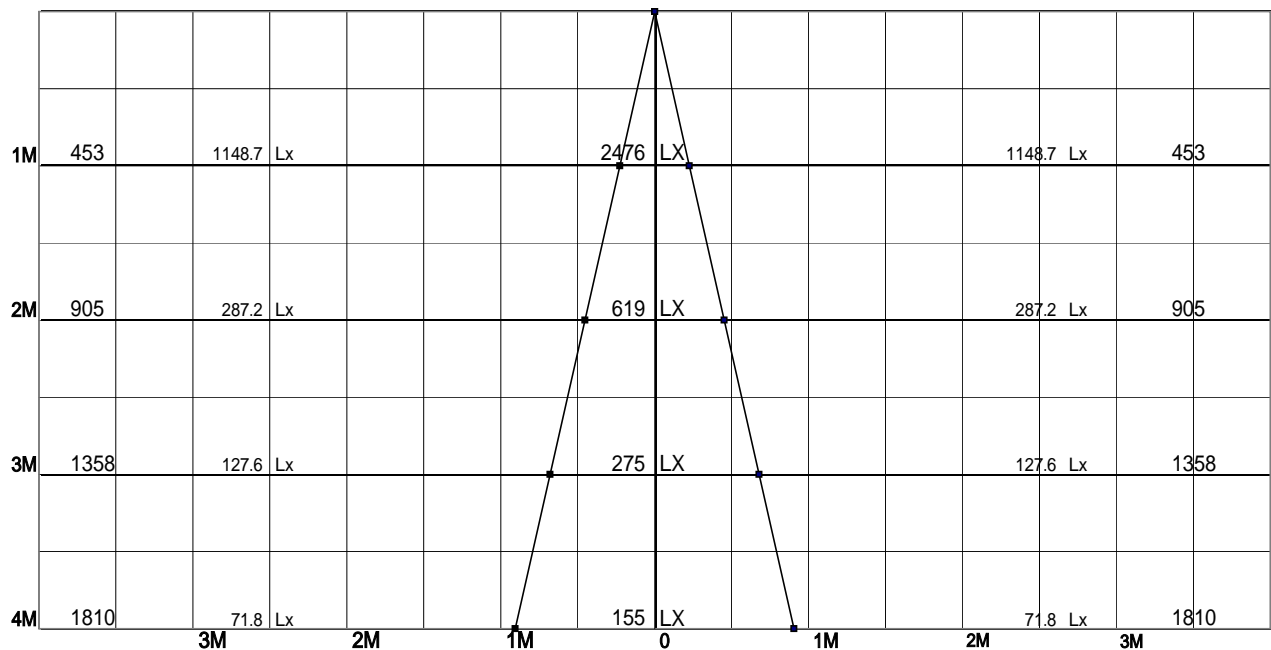

屋内照明器具特性



品名	DH-2985		
光源	CMH20/MR16/WFL		
光束	590 Lm	灯数	1 灯

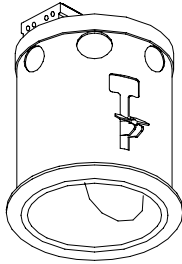

配光曲線図
実光度

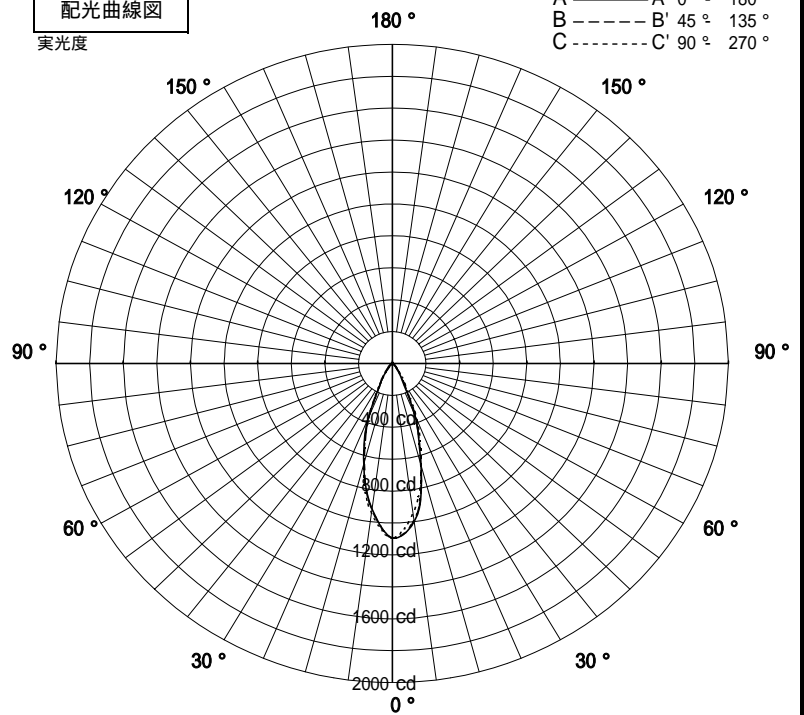

器具効率	80.8	%
上方効率	0.0	%
下方効率	80.7	%
保守率	良	0.65
	中	0.61
	否	0.54

1/2ビーム角		
A - A'	36.5	度
C - C'	36.5	度

A - A' Section

1/2ビーム角

C - C' Section

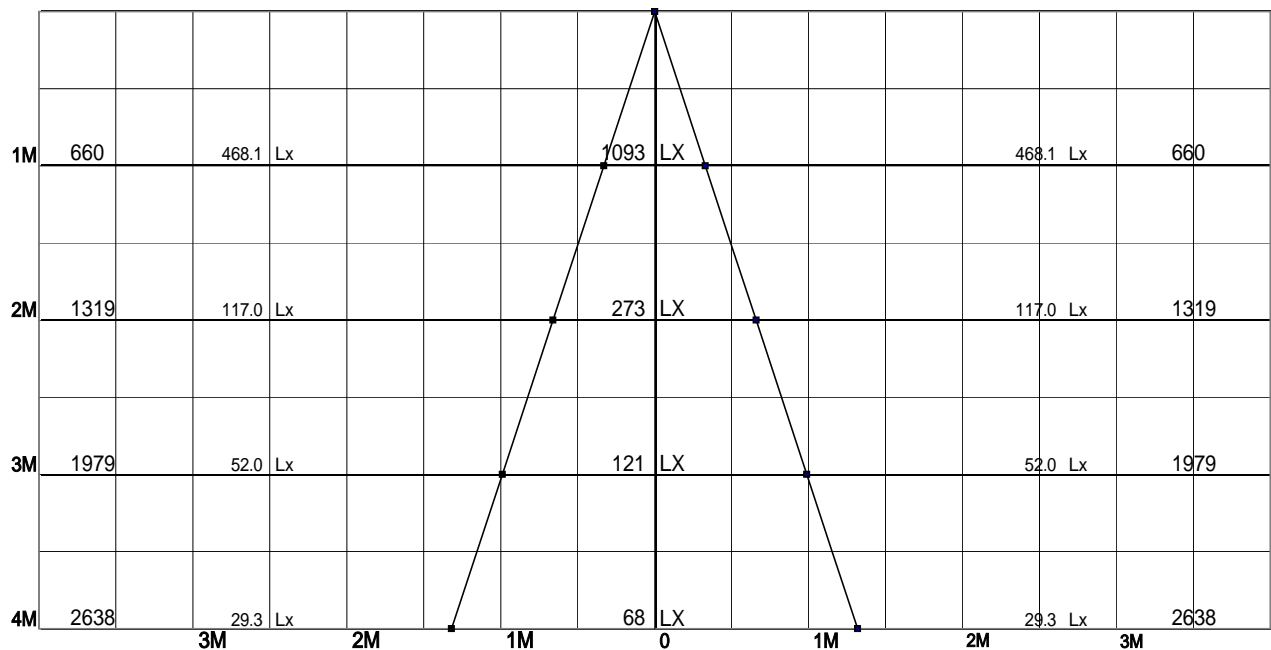

屋内照明器具特性



品名	DH-2985		
光源	CMH35/MR16/SP		
光束	1445 Lm	灯数	1 灯

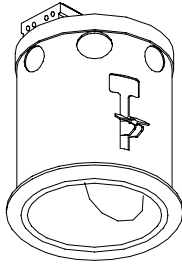

配光曲線図
実光度

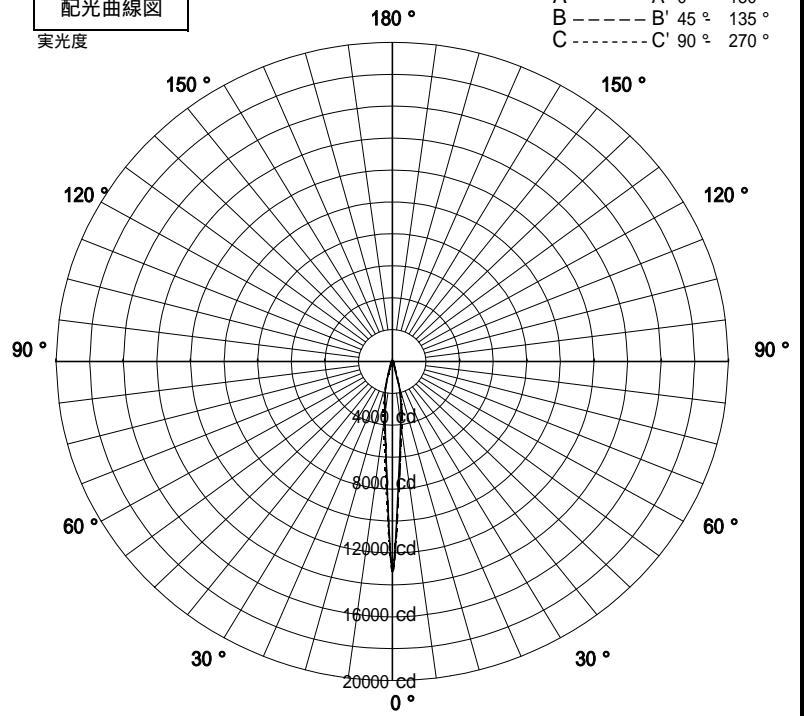

器具効率	87.0	%
上方効率	0.0	%
下方効率	87.0	%
保守率	良	0.65
	中	0.61
	否	0.54

1/2ビーム角		
A - A'	10.0	度
C - C'	15.0	度

A - A' Section

1/2ビーム角

C - C' Section

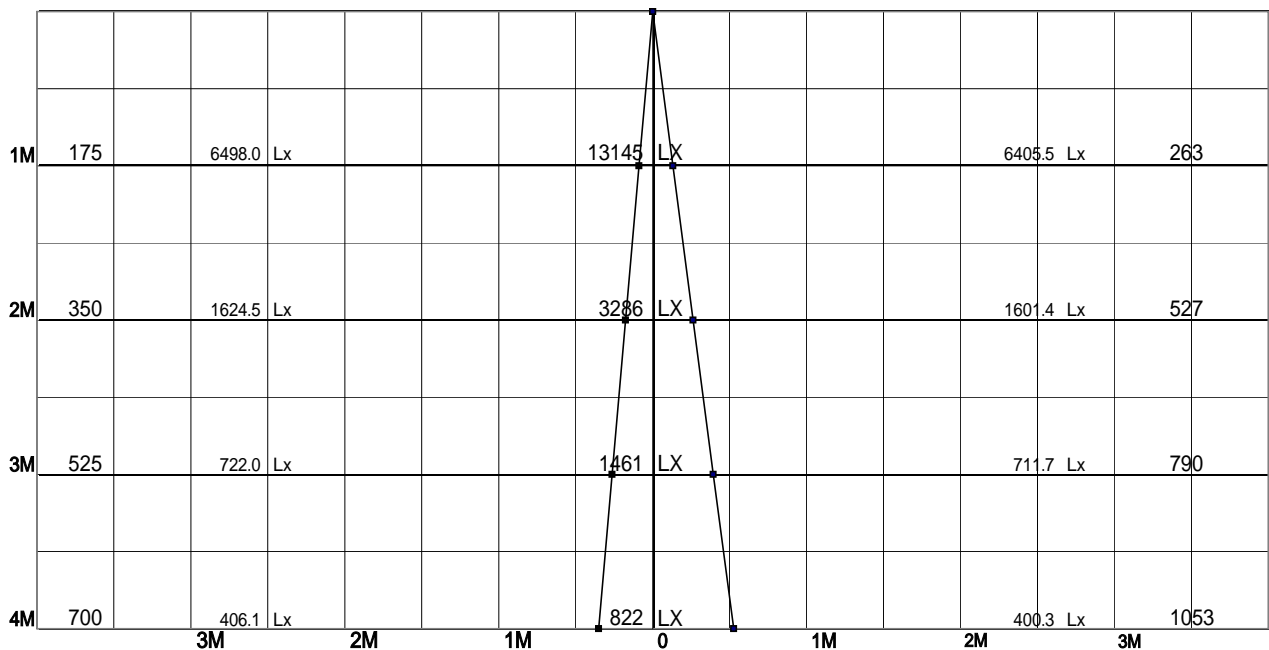

屋内照明器具特性



品名	DH-2985		
光源	CMH35/MR16/FL		
光束	1224 Lm	灯数	1 灯

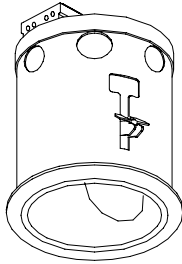

配光曲線図
実光度

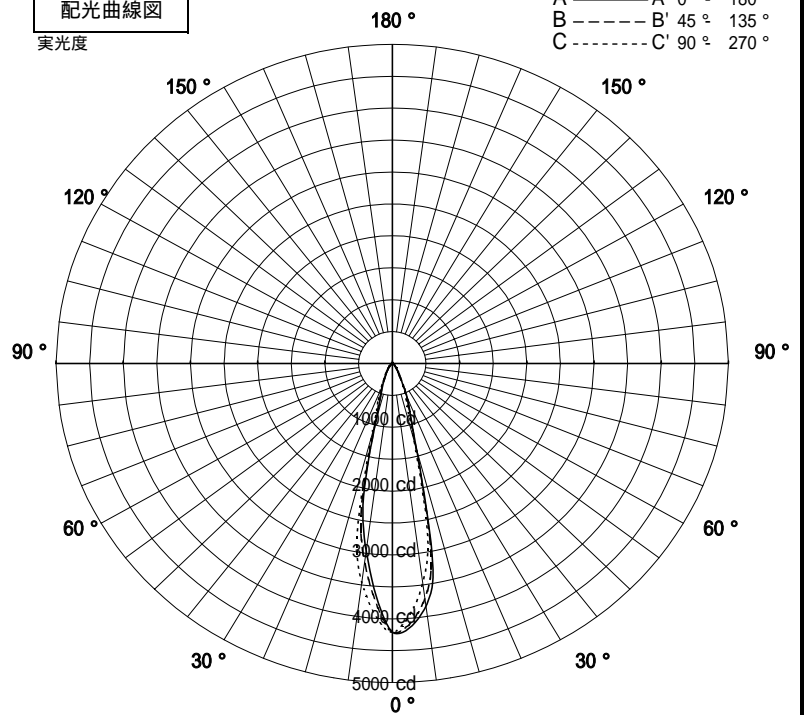

器具効率	86.9	%
上方効率	0.0	%
下方効率	86.9	%
保守率	良	0.65
	中	0.61
	否	0.54

1/2ビーム角		
A - A'	25.5	度
C - C'	25.5	度

A - A' Section

1/2ビーム角

C - C' Section

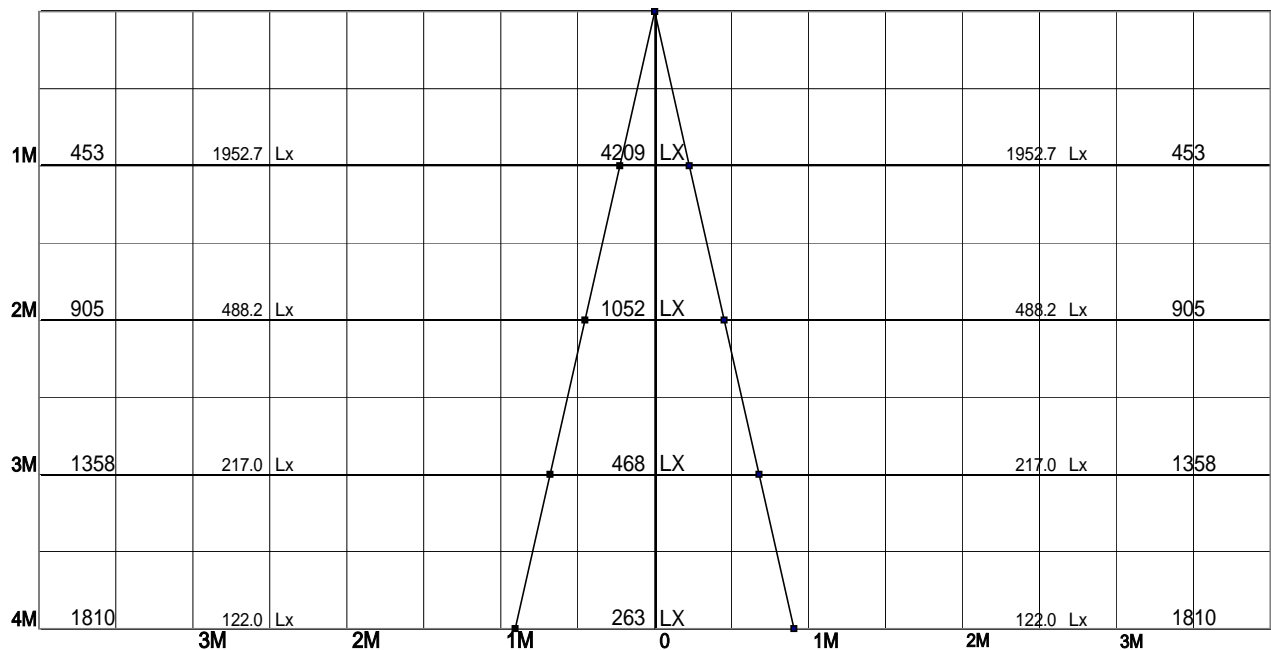

屋内照明器具特性



品名	DH-2985		
光源	CMH35/MR16/WFL		
光束	1003 Lm	灯数	1 灯

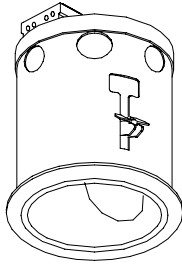

配光曲線図
実光度

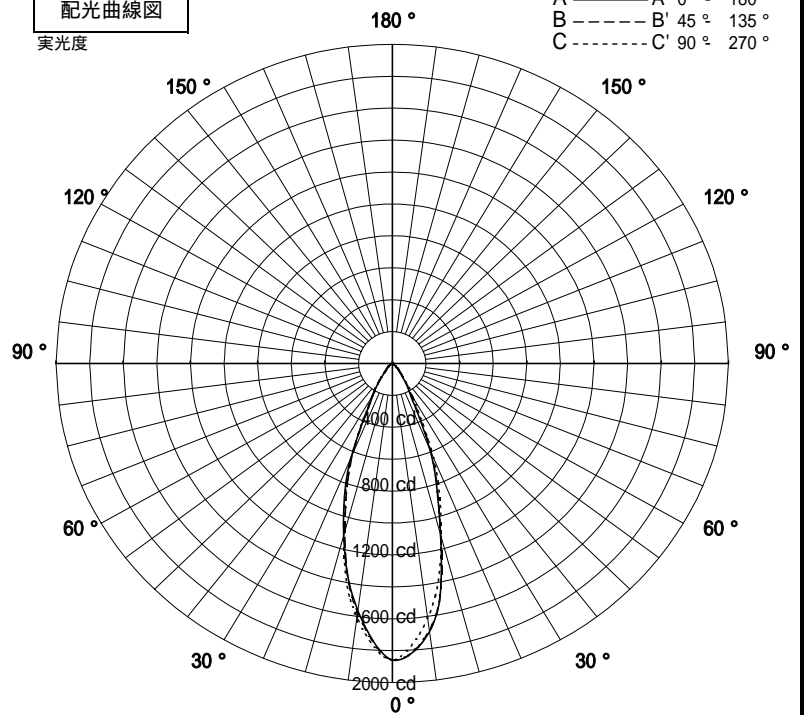

器具効率	80.8	%
上方効率	0.0	%
下方効率	80.7	%
保守率	良	0.65
	中	0.61
	否	0.54

1/2ビーム角		
A - A'	36.5	度
C - C'	36.5	度

A - A' Section

1/2ビーム角

C - C' Section

