

# 屋内照明器具特性

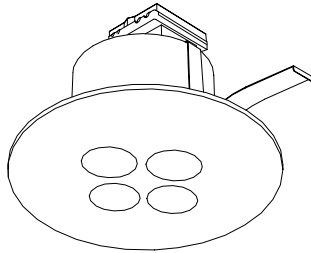

品名	DD-3019-N		
光源	WW-2002N		
光束	96 Lm	灯数	4 灯



配光曲線図

cd/1000lm

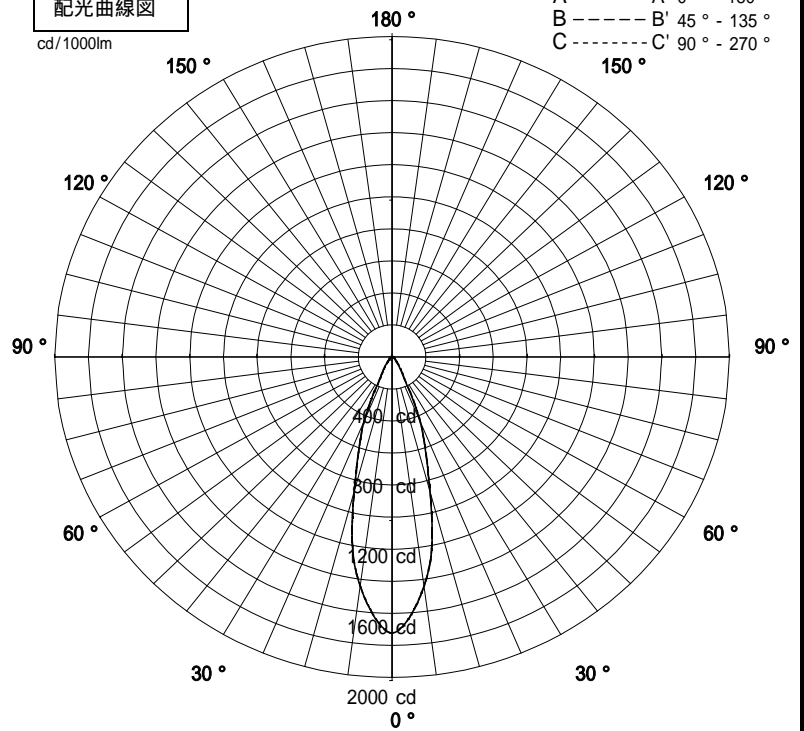

1/2照度角

直射水平面照度

単位:Lx

器具効率	62.1	%
上方効率	0.0	%
下方効率	62.1	%
保守率	良	1
	中	1
	否	1
1/2照度角		
A - A'	28.5	Deg
C - C'	28.5	Deg
最大取付間隔		
A - A'	0.51	H
C - C'	0.51	H

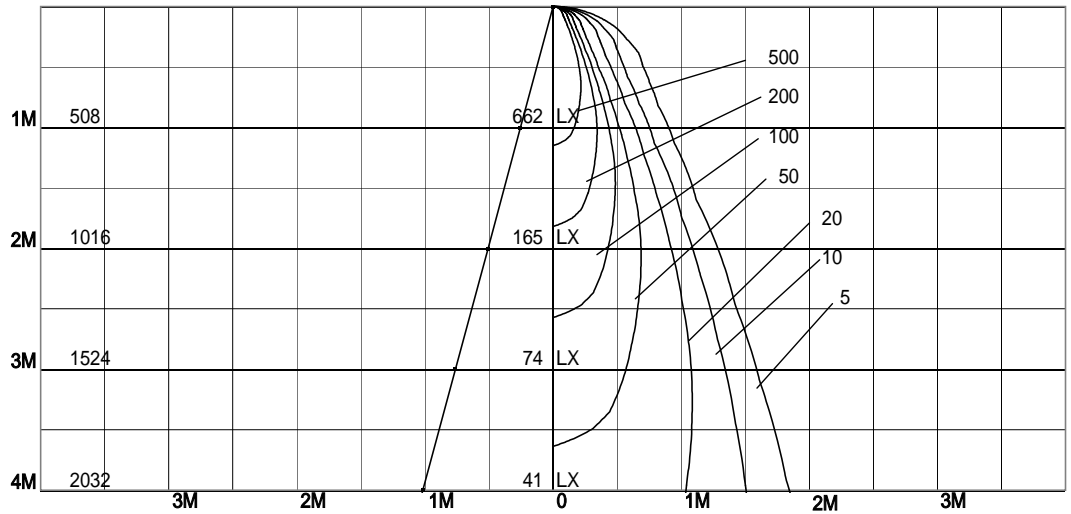

照明率表

天井	80%				70%				50%				30%				0%
	70%	50%	30%	10%	70%	50%	30%	10%	70%	50%	30%	10%	70%	50%	30%	10%	0%
壁	10%																
床	10%																
0.60	41	38	35	34	41	37	35	34	40	37	35	34	39	37	35	34	33
0.80	44	41	38	37	43	40	38	37	43	40	38	37	42	39	38	36	36
1.00	46	43	41	40	46	43	41	39	45	42	41	39	44	42	40	39	38
1.25	48	45	43	42	47	45	43	42	46	44	43	41	46	44	42	41	40
1.50	49	47	45	44	49	47	45	43	48	46	44	43	47	45	44	43	42
2.00	51	49	48	47	51	49	48	46	50	48	47	46	49	47	46	46	45
2.50	52	51	50	49	52	50	49	48	51	50	49	48	50	49	48	47	46
3.00	53	52	51	50	53	52	51	50	52	51	50	49	51	50	49	49	48
4.00	54	53	52	52	53	53	52	51	52	52	51	51	51	51	50	50	49
5.00	54	54	53	53	54	53	53	52	53	52	52	51	52	51	51	51	50
7.00	55	55	54	54	54	54	54	53	53	53	53	53	52	52	52	52	50
10.00	55	55	55	55	55	55	54	54	54	54	53	53	53	53	52	52	51