

# 屋内照明器具特性

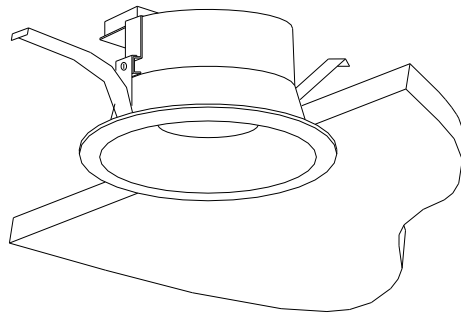

品名	DD-3173-L		
光源	LDF7L-H-GX53/3		
実効光束 (器具光束)	475lm	効率	70.9lm/W



配光曲線図  
cd/1000lm

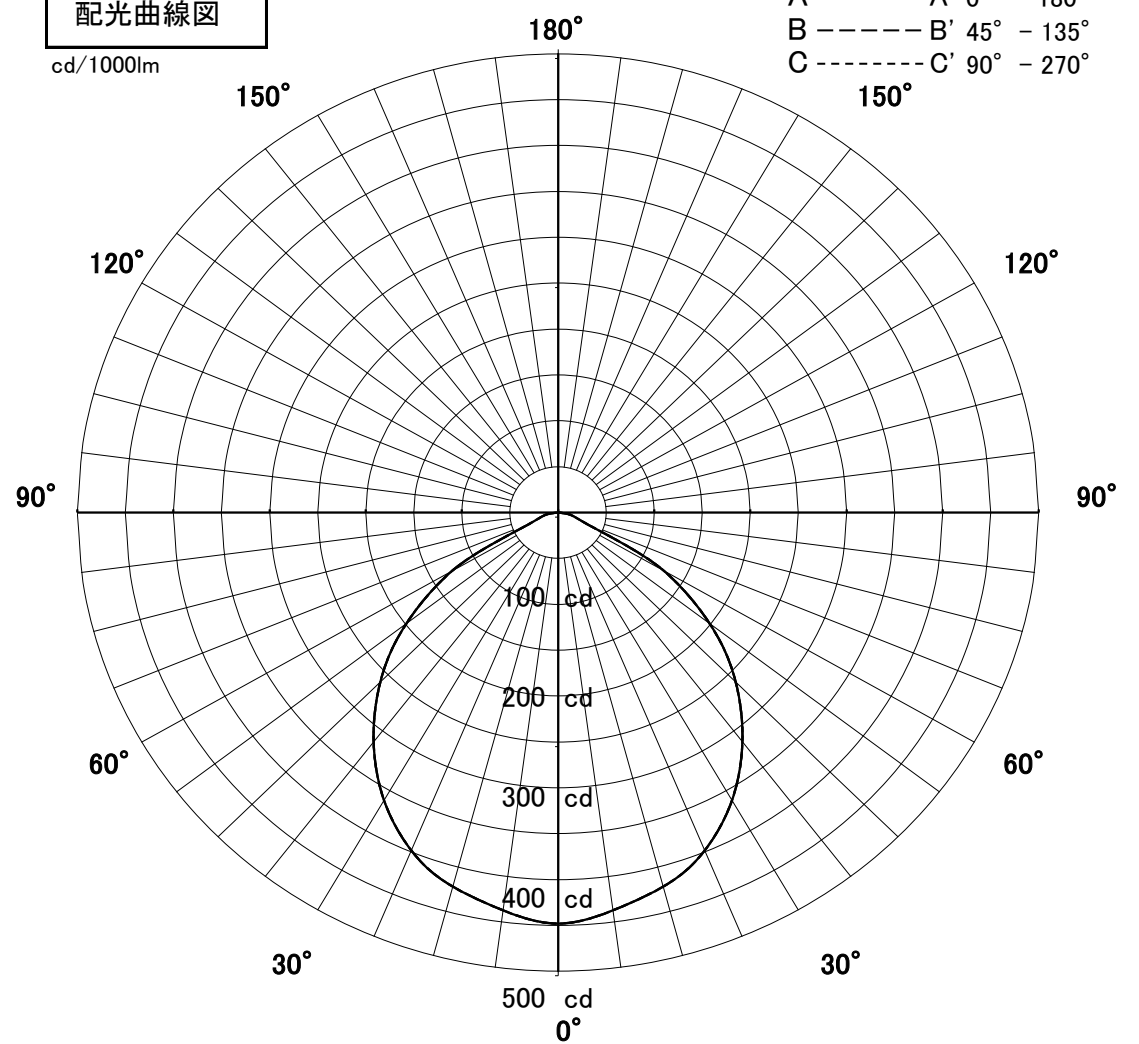

1/2照度角

直射水平面照度

単位:Lx

色温度	2700K	
演色評価指数	Ra83	
保守率	良	0.8
	中	0.6
	否	0.54

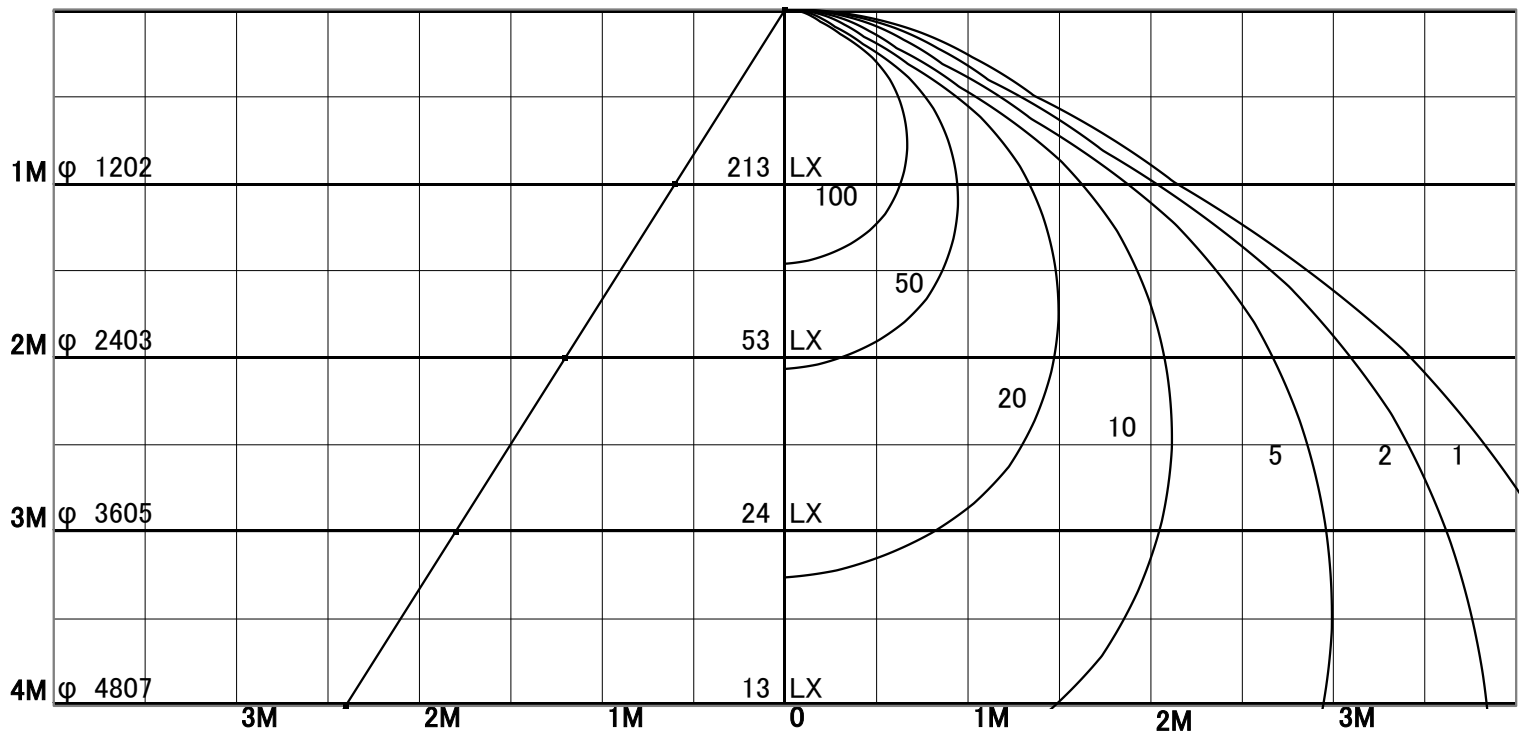

1/2照度角

A-A'	62.0	Deg
C-C'	62.0	Deg

最大取付間隔

A-A'	1.20	H
C-C'	1.20	H

照明率表

	80%				70%				50%				30%				0%
	70%	50%	30%	10%	70%	50%	30%	10%	70%	50%	30%	10%	70%	50%	30%	10%	0%
天井	10%																0%
壁	10%																0%
床	10%																0%
0.60	62	50	43	38	60	50	43	38	58	49	43	38	56	48	42	38	36
0.80	71	61	53	48	70	60	53	48	67	59	53	48	65	57	52	48	46
1.00	78	68	62	57	76	68	61	56	74	66	60	56	71	65	60	56	54
1.25	84	75	69	64	82	75	69	64	80	73	68	64	77	71	67	63	61
1.50	88	80	75	70	86	80	74	70	84	78	73	69	81	76	72	69	67
2.00	93	88	83	79	92	87	82	78	89	85	81	78	87	83	80	77	75
2.50	97	92	88	84	95	91	87	84	93	89	86	83	90	87	84	82	80
3.00	99	95	91	88	97	94	90	88	95	92	89	86	92	90	87	85	83
4.00	101	98	95	93	100	97	94	92	97	95	93	91	95	93	91	89	87
5.00	103	100	97	95	101	99	97	94	99	97	95	93	96	95	93	92	89
7.00	104	102	100	99	103	101	99	98	100	99	97	96	98	97	96	94	92
10.00	105	104	102	101	104	103	101	100	102	100	99	98	99	98	97	96	94