

# 屋内照明器具特性

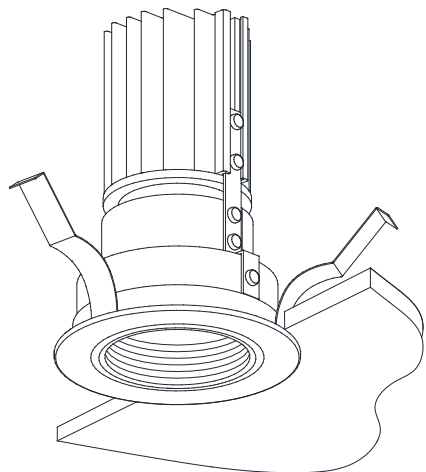

品名	DD-3183-L		
光源	LED16W		
実効光束 (器具光束)	545lm	エネルギー 効率	34.1lm/W



配光曲線図  
実光度

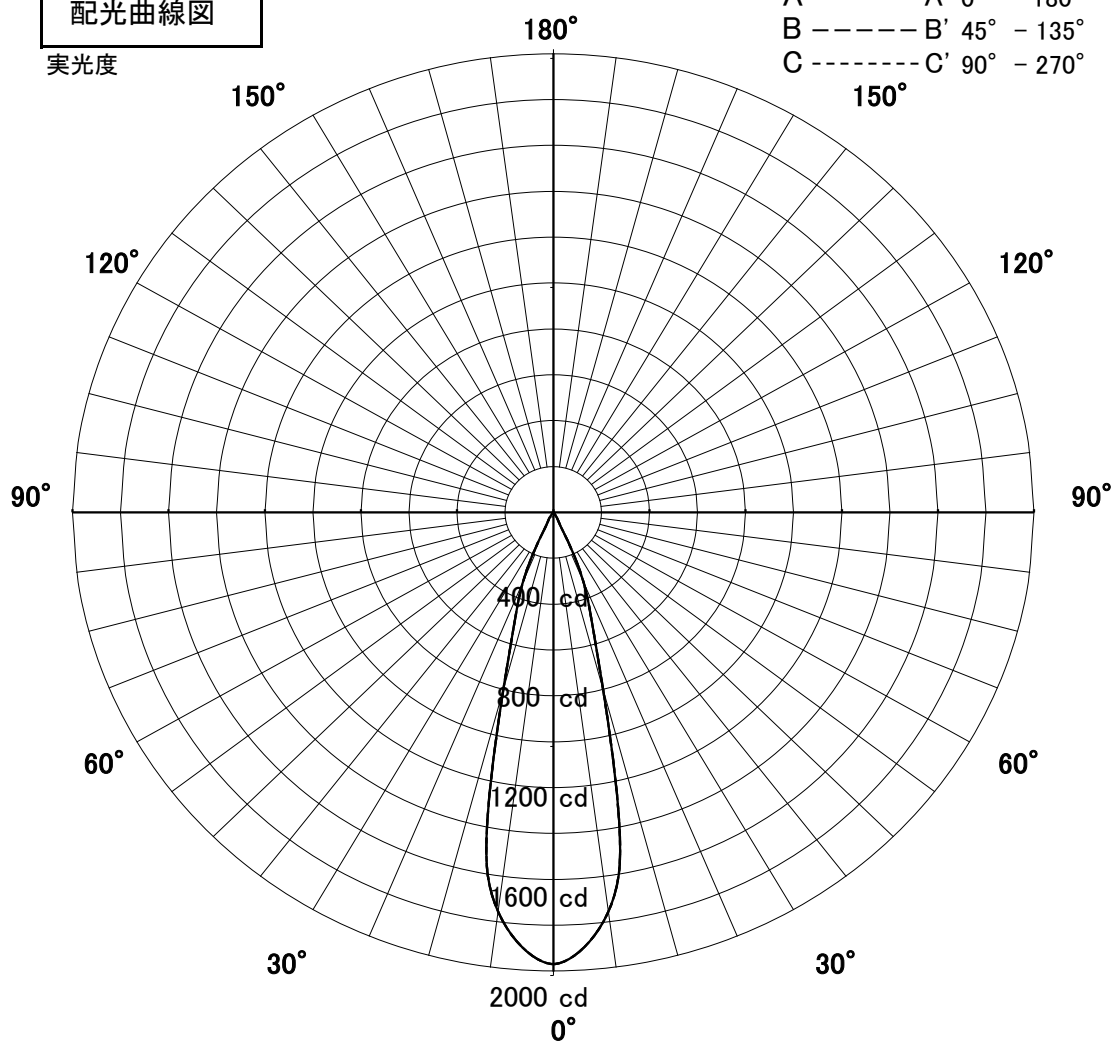

1/2照度角

直射水平面照度

単位: Lx

器具効率	34.6%	
色温度	3000K	
演色評価指数	Ra83	
保守率	良	0.67
	中	0.63
	否	0.56
1/2照度角		
A-A'	28.5	Deg
C-C'	28.5	Deg
最大取付間隔		
A-A'	0.51	H
C-C'	0.51	H

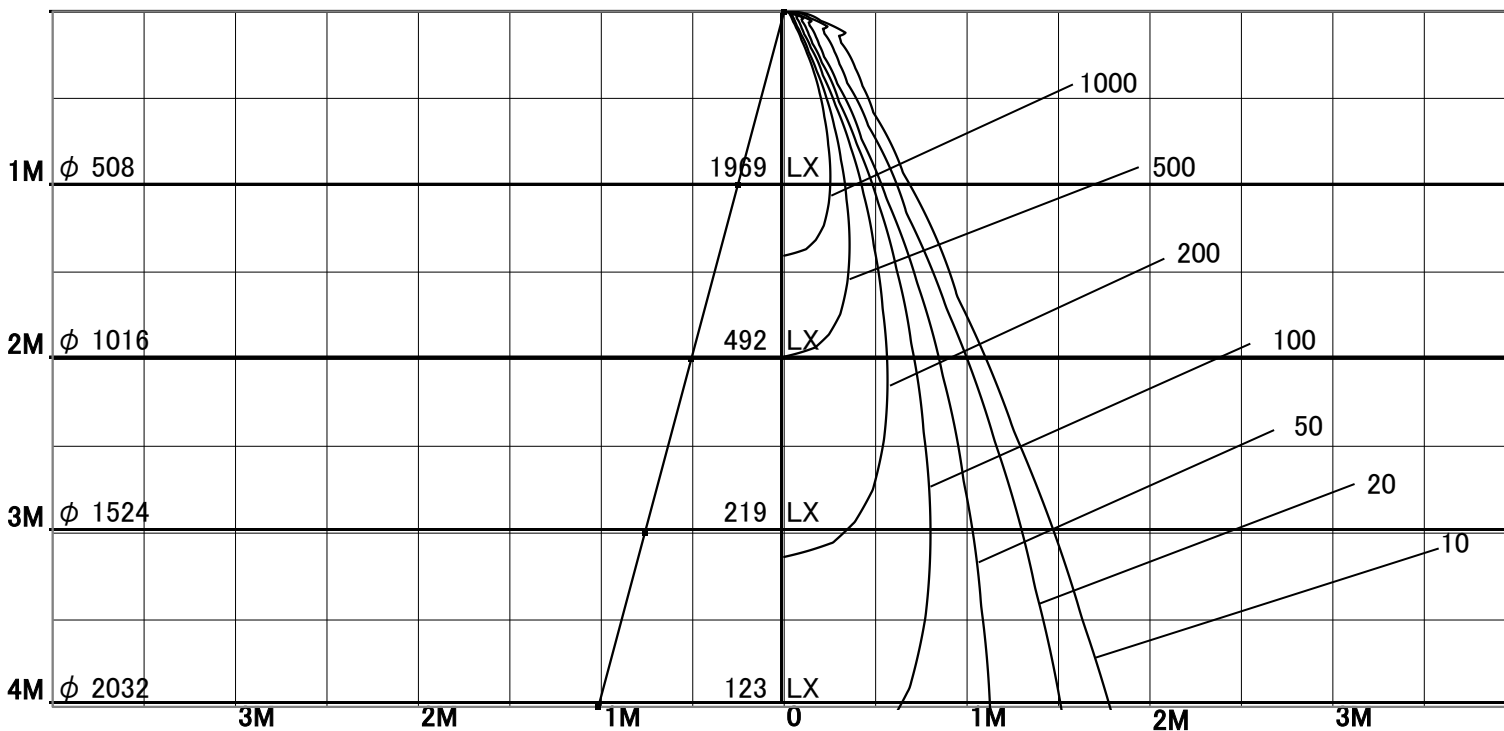

固有照明率表

	80%				70%				50%				30%				0%
	70%	50%	30%	10%	70%	50%	30%	10%	70%	50%	30%	10%	70%	50%	30%	10%	0%
天井	10%																0%
壁	10%																0%
床	10%																0%
0.60	89	83	79	76	88	82	79	76	87	82	78	76	85	81	78	76	75
0.80	93	88	84	81	92	87	84	81	91	86	83	81	89	86	83	81	79
1.00	97	93	89	86	97	92	89	86	95	91	88	86	93	90	87	85	84
1.25	100	96	93	90	100	96	93	90	98	94	92	90	96	93	91	89	88
1.50	103	99	96	93	102	98	95	93	100	97	94	92	98	96	93	92	90
2.00	106	103	101	99	105	102	100	98	103	101	99	97	101	99	98	97	95
2.50	108	106	104	102	107	105	103	102	105	103	102	101	103	102	101	100	98
3.00	109	108	106	105	108	107	106	104	106	105	104	103	105	104	103	102	100
4.00	111	109	109	108	109	109	108	107	108	107	106	105	106	105	105	104	102
5.00	111	110	110	109	110	110	109	108	108	108	107	107	106	106	106	105	103
7.00	112	112	111	111	111	111	111	110	109	109	109	109	107	107	107	107	104
10.00	113	113	113	112	112	112	111	111	110	110	110	110	108	108	108	108	105