

屋内照明器具特性

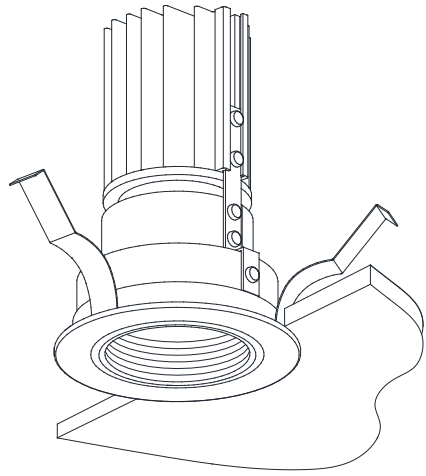

品名	DD-3184-N		
光源	LED16W		
実効光束 (器具光束)	843lm	エネルギー 効率	52.7lm/W



配光曲線図
実光度

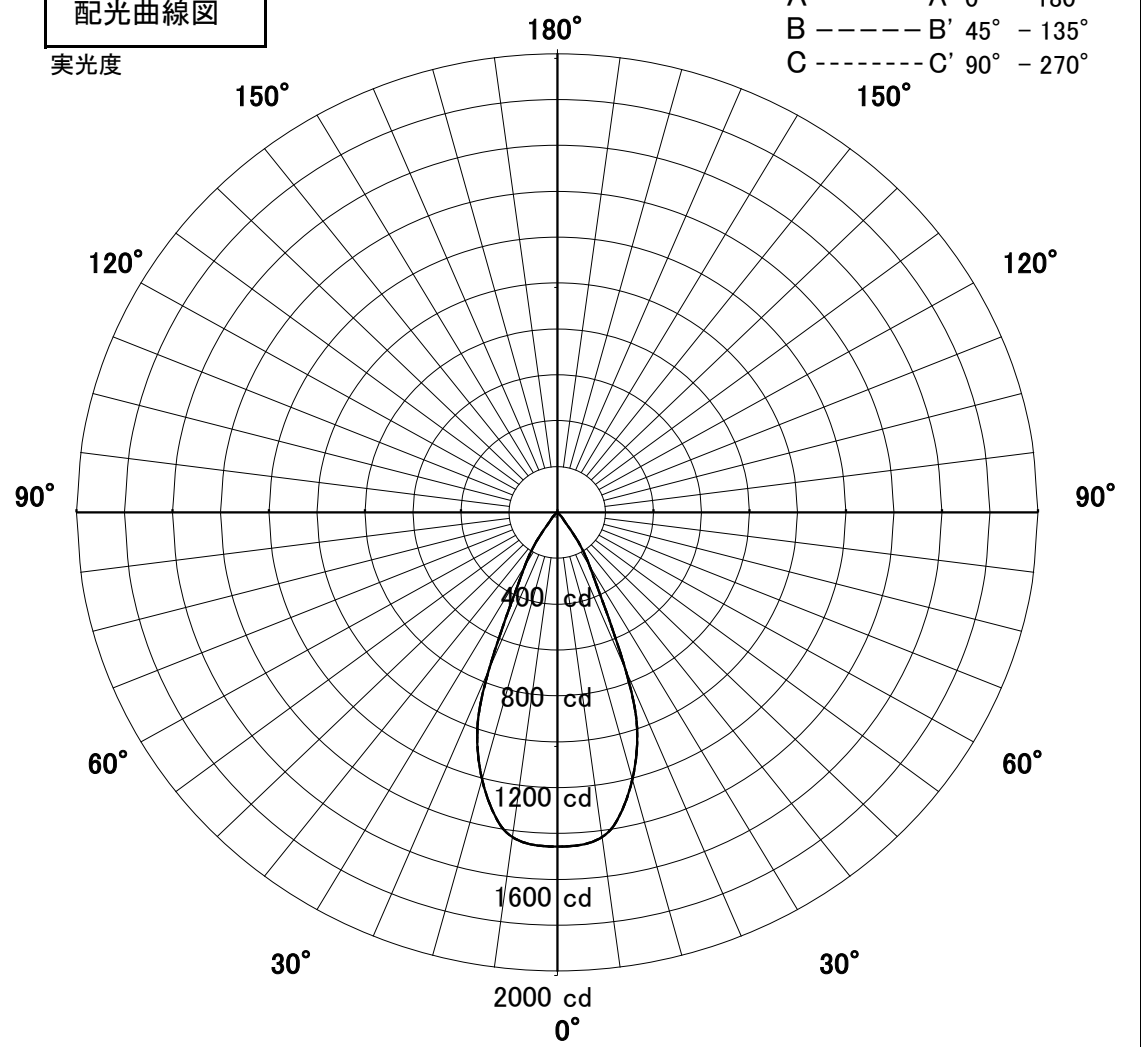

1/2照度角

直射水平面照度

単位: Lx

器具効率	51.1%	
色温度	5000K	
演色評価指数	Ra83	
保守率	良	0.67
	中	0.63
	否	0.56
1/2照度角		
A-A'	41.5	Deg
C-C'	41.5	Deg
最大取付間隔		
A-A'	0.76	H
C-C'	0.76	H

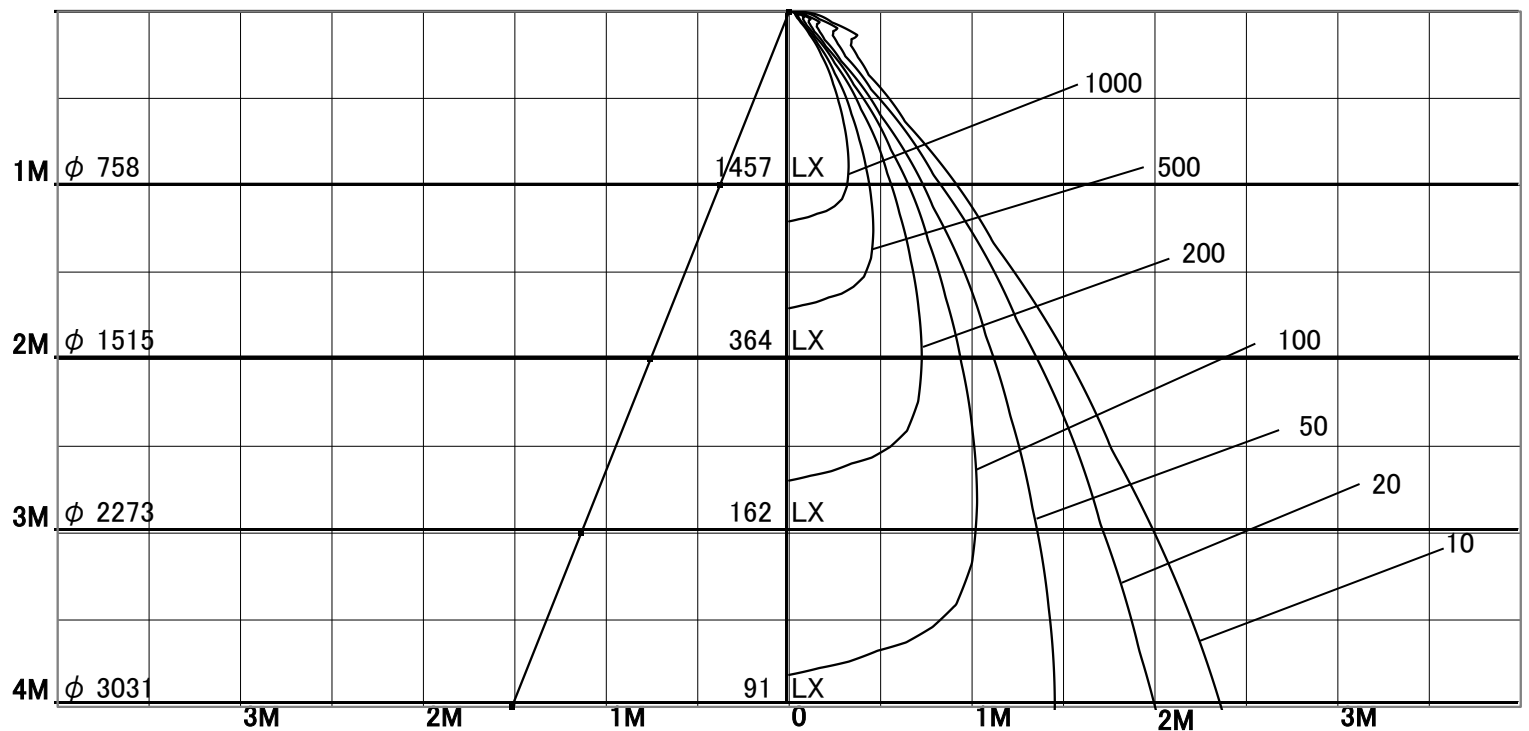

固有照明率表

	80%				70%				50%				30%				0%
	70%	50%	30%	10%	70%	50%	30%	10%	70%	50%	30%	10%	70%	50%	30%	10%	0%
天井	10%																0%
壁	10%																0%
床	10%																0%
0.60	86	80	76	74	85	80	76	73	84	79	76	73	83	78	75	73	72
0.80	90	85	81	78	90	85	81	78	88	84	80	78	87	83	80	78	77
1.00	95	90	86	84	94	89	86	83	92	88	85	83	90	87	85	83	81
1.25	98	93	90	88	97	93	90	87	95	92	89	87	93	90	88	86	85
1.50	100	96	93	91	99	95	93	90	97	94	92	90	95	93	91	89	88
2.00	103	100	98	96	102	99	97	96	100	98	96	95	98	97	95	94	92
2.50	105	103	101	100	104	102	100	99	102	100	99	98	100	99	98	97	95
3.00	106	105	103	102	105	104	103	101	103	102	101	100	102	101	100	99	97
4.00	107	106	105	105	106	105	105	104	105	104	103	102	103	102	102	101	99
5.00	108	107	107	106	107	106	106	105	105	105	104	104	103	103	103	102	100
7.00	109	109	108	108	108	108	107	107	106	106	106	105	104	104	104	104	101
10.00	109	109	109	109	108	108	108	108	106	106	106	106	105	105	105	105	102