

屋内照明器具特性

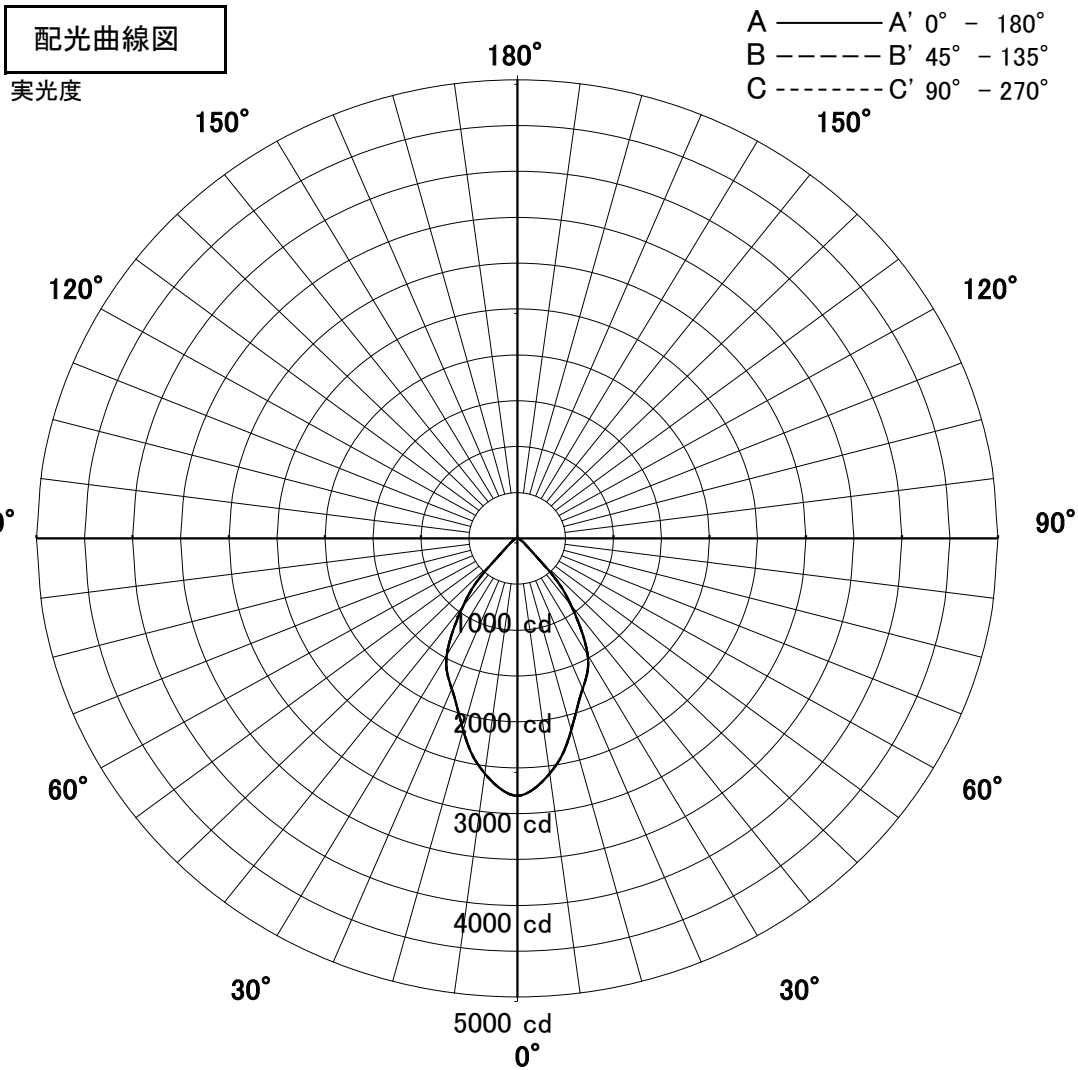

品名	DD-3192-N		
光源	LED30W		
実効光束 (器具光束)	2770lm	エネルギー 効率	92.3lm/W

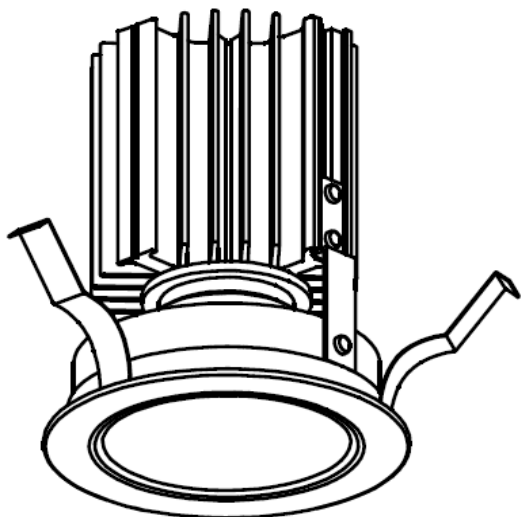

1/2照度角

直射水平面照度

単位: Lx

器具効率	88.3%	
色温度	5000K	
演色評価指数	Ra83	
保守率	良	0.67
	中	0.63
	否	0.56
1/2照度角		
A-A'	44.5	Deg
C-C'	44.5	Deg
最大取付間隔		
A-A'	0.82	H
C-C'	0.82	H

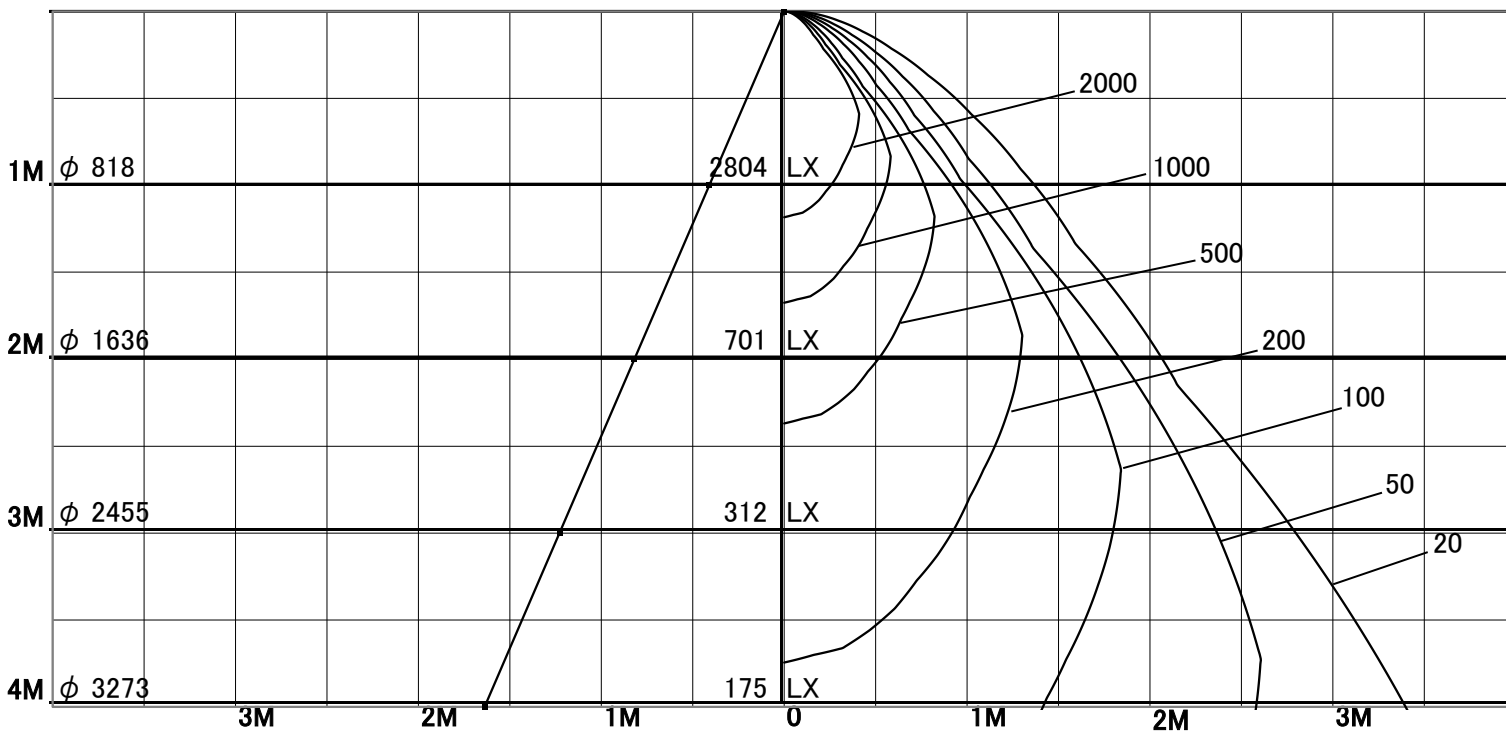

固有照明率表

	80%				70%				50%				30%				0%
	70%	50%	30%	10%	70%	50%	30%	10%	70%	50%	30%	10%	70%	50%	30%	10%	0%
天井	10%																0%
壁	10%																0%
床	10%																0%
0.60	79	71	66	63	78	71	66	63	76	70	66	63	75	69	66	63	61
0.80	85	78	73	70	84	78	73	70	82	77	73	70	81	76	72	69	68
1.00	90	84	80	76	89	84	79	76	87	82	79	76	86	81	78	75	74
1.25	94	89	85	82	93	88	84	81	91	87	84	81	89	86	83	80	79
1.50	97	92	89	86	96	92	88	85	94	90	87	85	92	89	86	84	82
2.00	101	97	94	92	100	97	94	92	98	95	93	91	96	94	92	90	88
2.50	103	101	98	96	102	100	97	96	100	98	96	95	98	96	95	94	92
3.00	105	103	101	99	104	102	100	98	102	100	99	97	100	98	97	96	94
4.00	106	105	103	102	105	104	102	101	103	102	101	100	101	100	99	98	96
5.00	107	106	105	104	106	105	104	103	104	103	102	101	102	101	101	100	97
7.00	108	107	107	106	107	106	106	105	105	104	104	103	103	102	102	102	99
10.00	109	108	108	107	108	107	107	106	106	105	105	104	104	103	103	103	100