

# 屋内照明器具特性

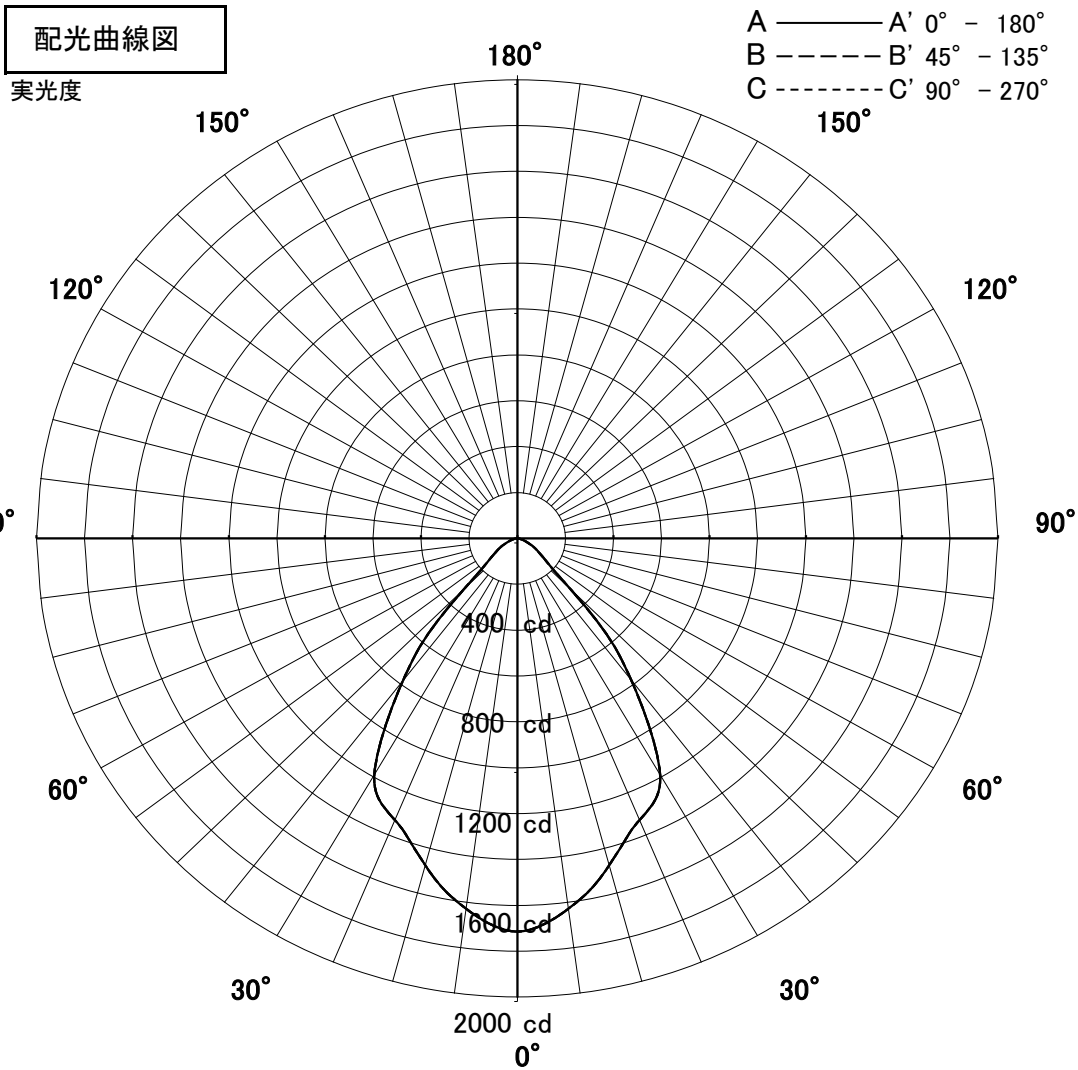

品名	DD-3193-LL		
光源	LED30W		
実効光束 (器具光束)	2241lm	エネルギー 効率	74.7lm/W

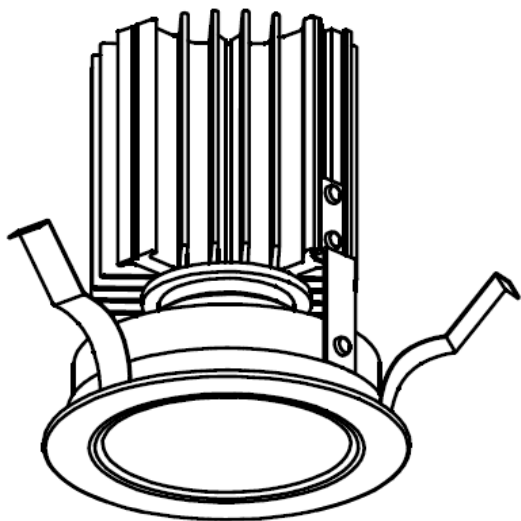

1/2照度角

直射水平面照度

単位: Lx

器具効率	78.4%	
色温度	2700K	
演色評価指数	Ra83	
保守率	良	0.67
	中	0.63
	否	0.56
1/2照度角		
A-A'	55.5	Deg
C-C'	55.5	Deg
最大取付間隔		
A-A'	1.05	H
C-C'	1.05	H

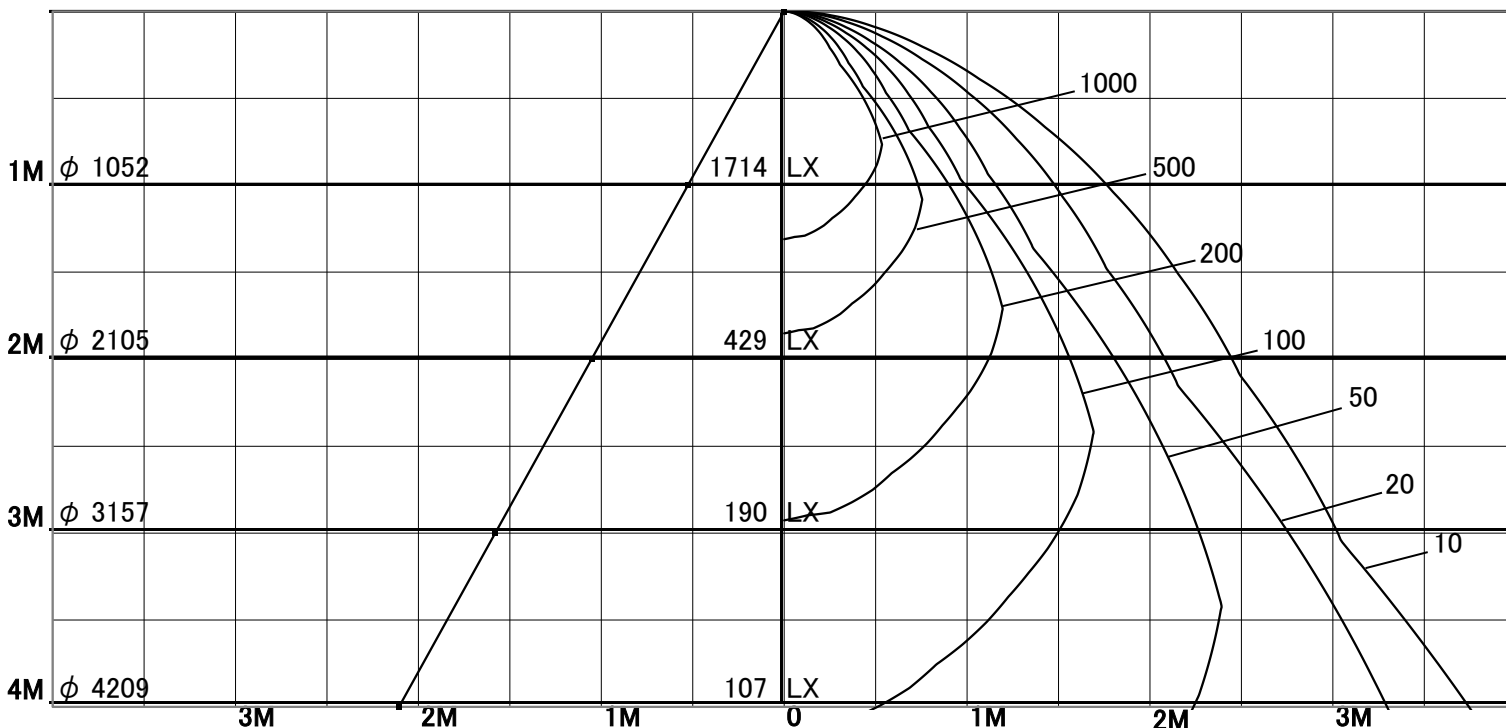

固有照明率表

天井	80%				70%				50%				30%				0%
	70%	50%	30%	10%	70%	50%	30%	10%	70%	50%	30%	10%	70%	50%	30%	10%	0%
壁	10%																0%
床	10%																0%
0.60	76	67	62	58	75	67	62	58	73	66	62	58	71	65	61	58	57
0.80	83	75	70	66	82	74	69	66	80	73	69	65	78	72	68	65	64
1.00	88	81	76	72	87	80	76	72	85	79	75	72	83	78	74	72	70
1.25	92	86	82	78	91	86	81	78	89	84	81	78	87	83	80	77	75
1.50	95	90	86	83	94	89	85	82	92	88	84	82	90	86	83	81	79
2.00	100	96	92	89	98	95	92	89	96	93	90	88	94	92	89	87	85
2.50	102	99	96	94	101	98	95	93	99	96	94	92	97	95	93	91	89
3.00	104	101	99	97	103	100	98	96	100	98	97	95	98	97	95	94	92
4.00	105	103	102	100	104	103	101	99	102	101	99	98	100	99	98	97	94
5.00	106	105	103	102	105	104	103	101	103	102	101	100	101	100	99	98	96
7.00	108	106	105	105	106	105	105	104	104	103	103	102	102	102	101	100	98
10.00	108	108	107	106	107	106	106	105	105	104	104	103	103	102	102	102	99