

屋内照明器具特性

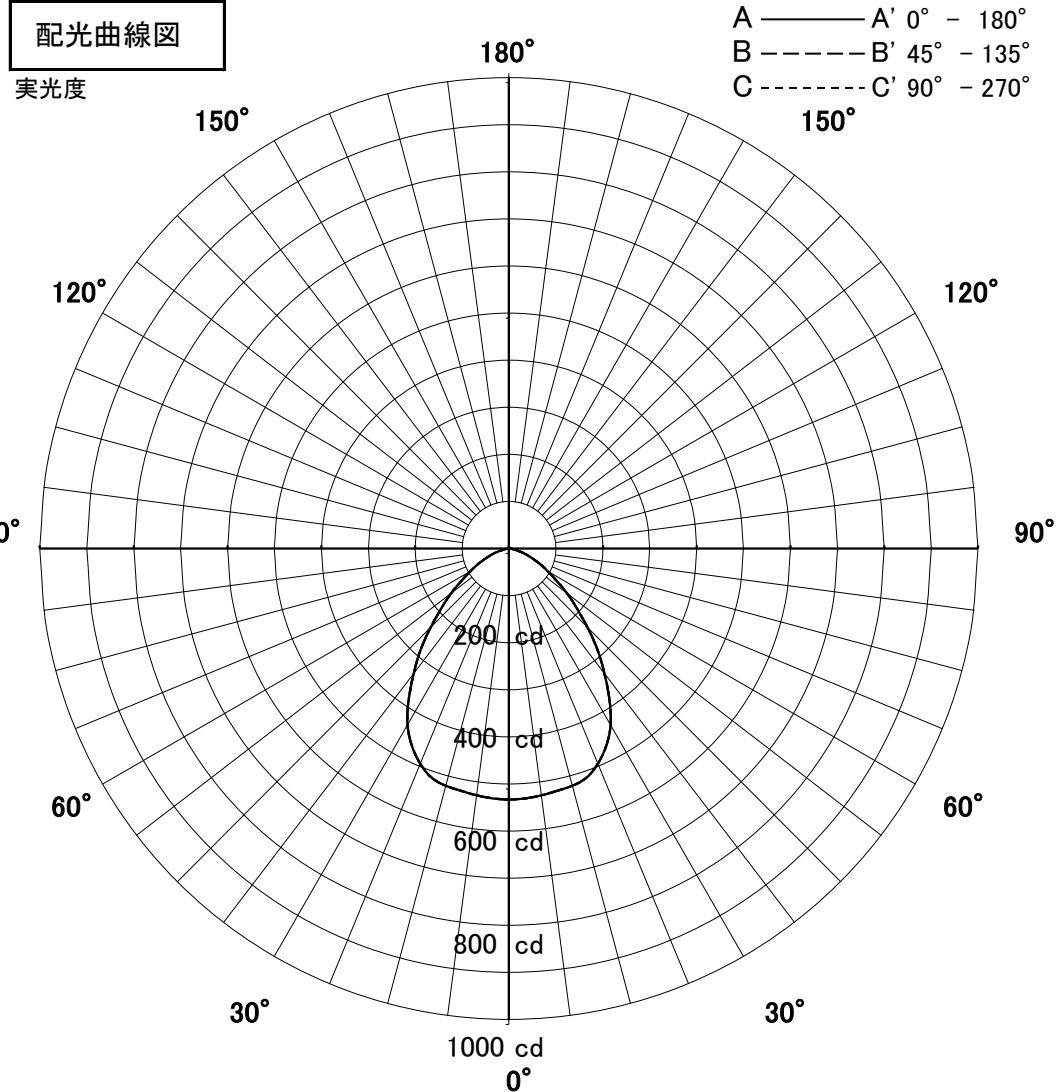

品名	DD-3195-W		
光源	LEC4/15W-W11GH40		
実効光束 (器具光束)	1052lm	効率	69lm/W

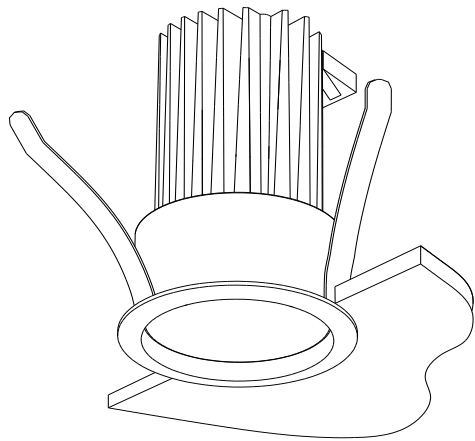

1/2照度角

直射水平面照度

単位:Lx

色温度	4000K	
演色評価指数	Ra80	
保守率	良	0.8
	中	0.6
	否	0.54

1/2照度角		
A-A'	62.0	Deg
C-C'	62.0	Deg
最大取付間隔		
A-A'	1.20	H
C-C'	1.20	H

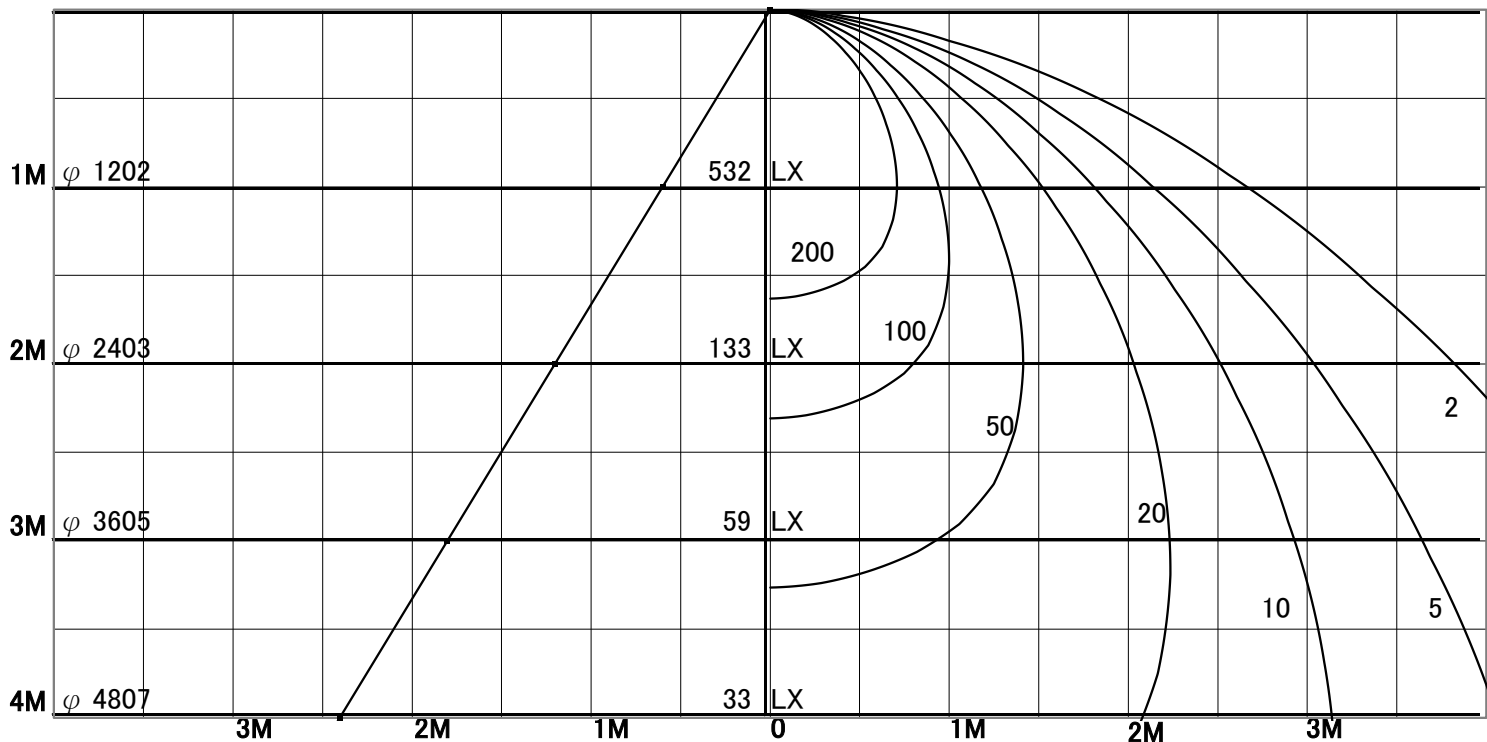

照明率表

天井	80%				70%				50%				30%				0%
	70%	50%	30%	10%	70%	50%	30%	10%	70%	50%	30%	10%	70%	50%	30%	10%	
壁	10%																
床	10%																
0.60	65	55	48	44	64	54	48	44	62	53	48	44	60	53	47	44	42
0.80	73	64	57	53	72	63	57	53	70	62	56	52	68	61	56	52	50
1.00	80	71	65	60	78	70	64	60	76	69	64	60	74	68	63	59	57
1.25	85	77	72	67	84	77	71	67	81	75	70	66	79	74	69	66	64
1.50	89	82	77	72	87	81	76	72	85	79	75	71	82	78	74	71	69
2.00	94	88	84	80	92	87	83	80	90	86	82	79	88	84	81	78	76
2.50	97	92	89	86	95	91	88	85	93	90	87	84	91	88	85	83	81
3.00	99	95	92	89	98	94	91	89	95	92	90	87	93	90	88	86	84
4.00	101	98	96	93	100	97	95	93	97	95	93	91	95	93	92	90	88
5.00	102	100	98	96	101	99	97	95	99	97	95	94	96	95	94	92	90
7.00	104	102	101	99	103	101	100	98	100	99	98	97	98	97	96	95	92
10.00	105	104	102	101	104	102	101	100	101	100	99	99	99	98	98	97	94