

# 屋内照明器具特性

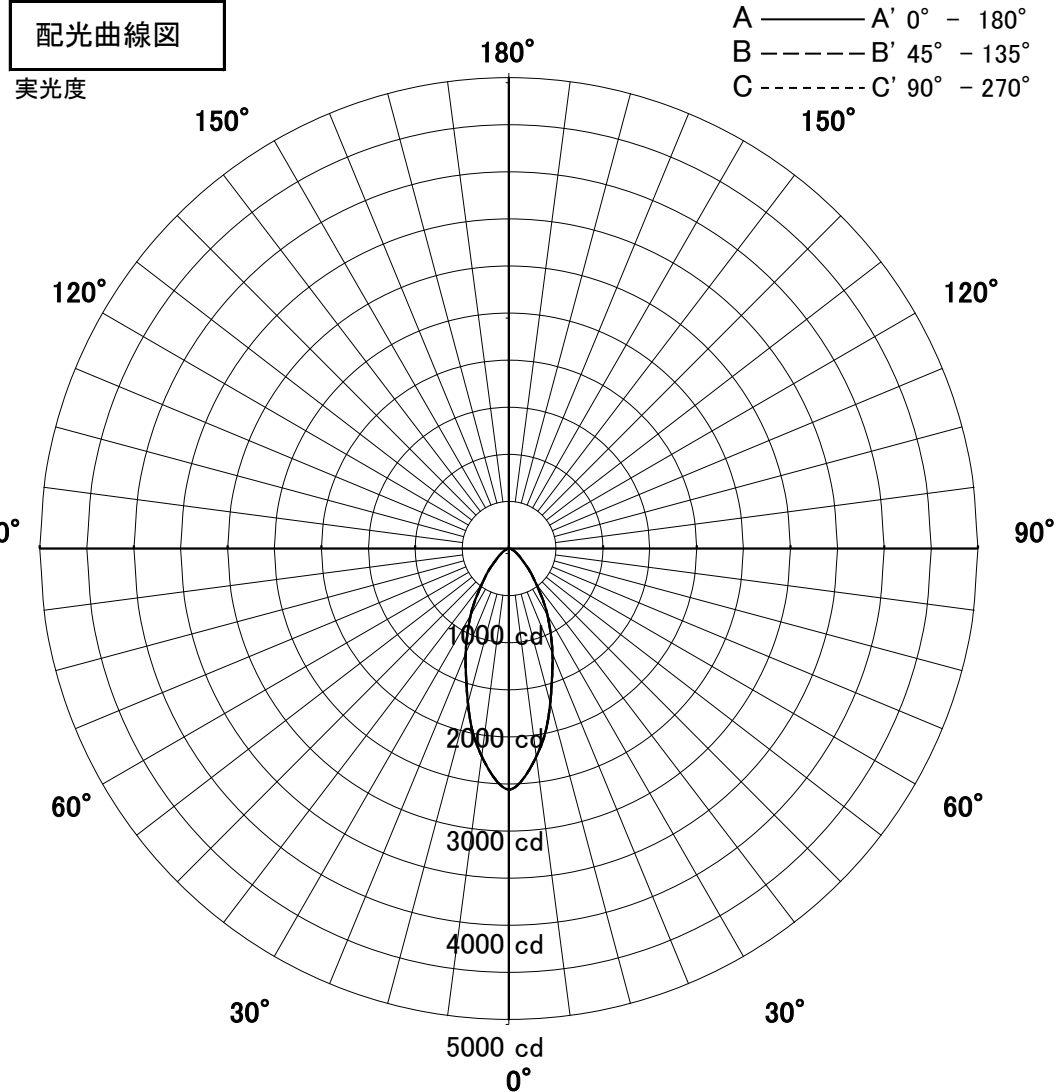

品名	DD-3204-N		
光源	LECF/24N-M20GHP50		
実効光束 (器具光束)	1968lm	効率	81lm/W

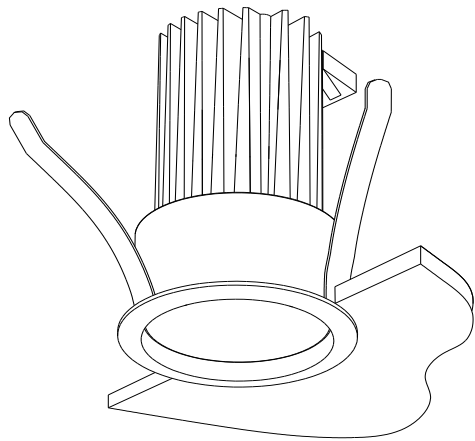

1/2照度角

直射水平面照度

単位:Lx

色温度	5000K	
演色評価指数	Ra70	
保守率	良	0.8
	中	0.6
	否	0.54

1/2照度角		
A-A'	36.0	Deg
C-C'	36.0	Deg
最大取付間隔		
A-A'	0.65	H
C-C'	0.65	H

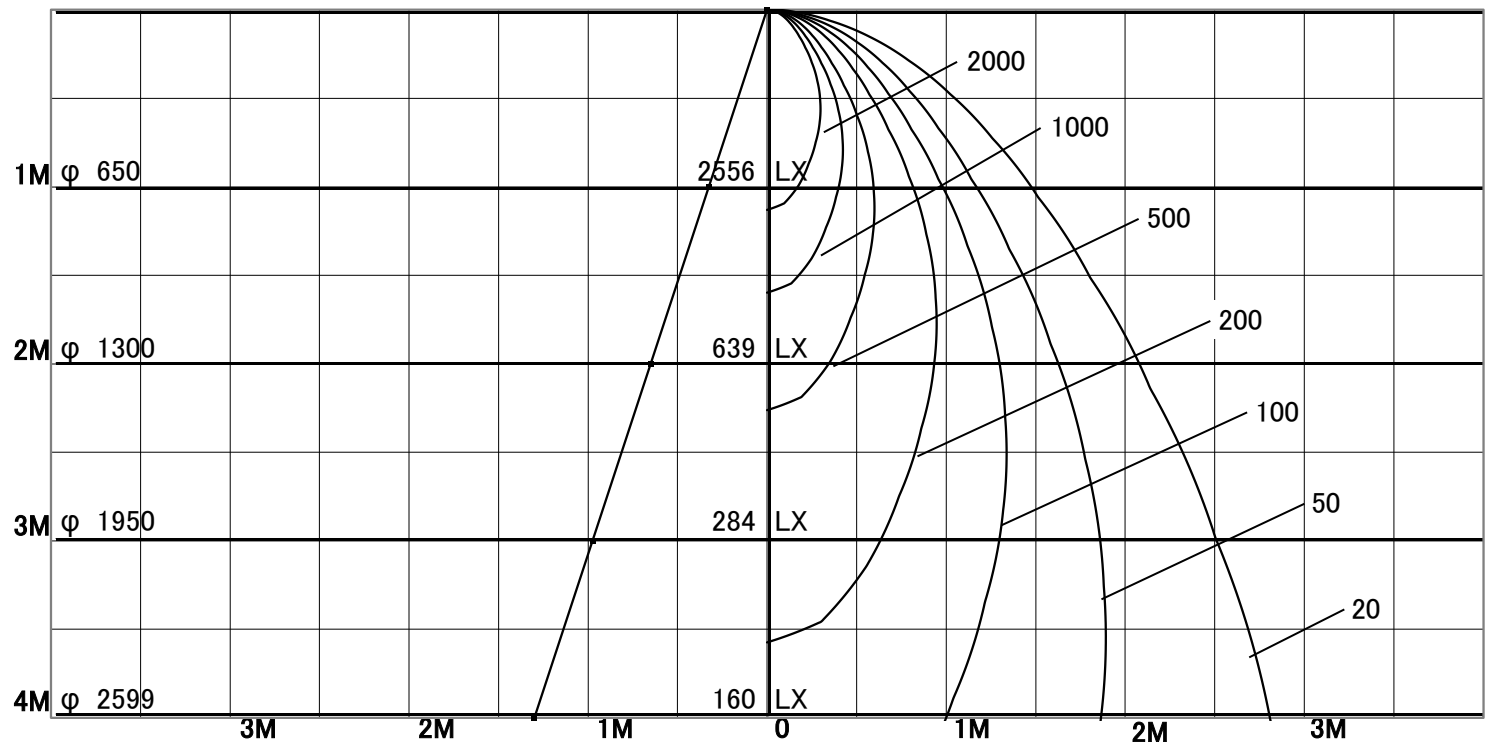

照明率表

天井	80%				70%				50%				30%				0%
	70%	50%	30%	10%	70%	50%	30%	10%	70%	50%	30%	10%	70%	50%	30%	10%	
壁	10%																
床	10%																
0.60	70	62	57	54	69	62	57	54	67	61	57	53	66	60	56	53	52
0.80	76	69	64	60	75	68	64	60	73	67	63	60	72	66	63	60	58
1.00	81	75	70	66	80	74	70	66	78	73	69	66	76	72	68	66	64
1.25	85	79	75	72	84	79	75	72	82	78	74	71	80	76	73	71	69
1.50	88	83	79	76	87	82	79	76	85	81	78	75	83	79	77	74	73
2.00	92	88	85	82	91	87	84	82	89	86	83	81	87	84	82	80	78
2.50	94	91	89	86	93	90	88	86	91	89	87	85	89	87	86	84	82
3.00	96	93	91	89	95	93	91	89	93	91	89	88	91	89	88	87	85
4.00	98	96	94	92	97	95	93	92	95	93	92	91	93	91	90	89	87
5.00	99	97	96	94	97	96	95	94	95	94	93	92	94	93	92	91	89
7.00	100	99	98	97	99	98	97	96	97	96	95	94	95	94	93	93	90
10.00	100	100	99	98	99	99	98	98	97	97	96	96	95	95	95	94	92