

# 屋内照明器具特性

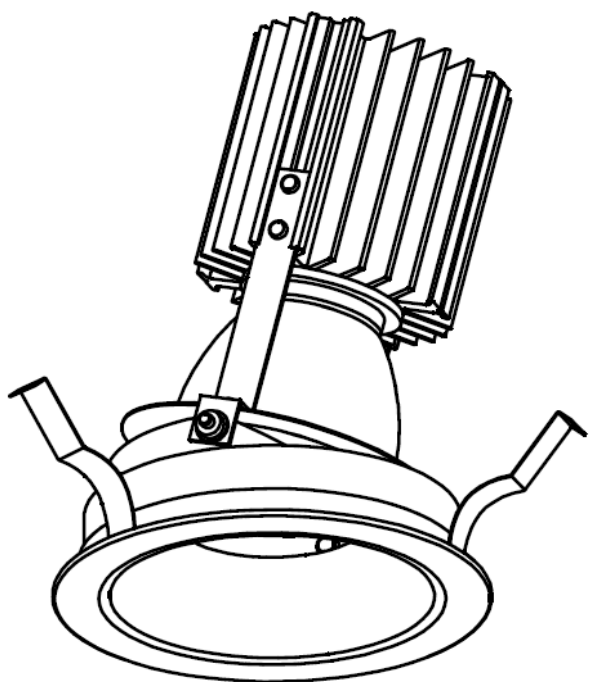

品名	DD-3212-L		
光源	LED30W		
実効光束 (器具光束)	1470lm	エネルギー 効率	49.0lm/W



配光曲線図  
実光度

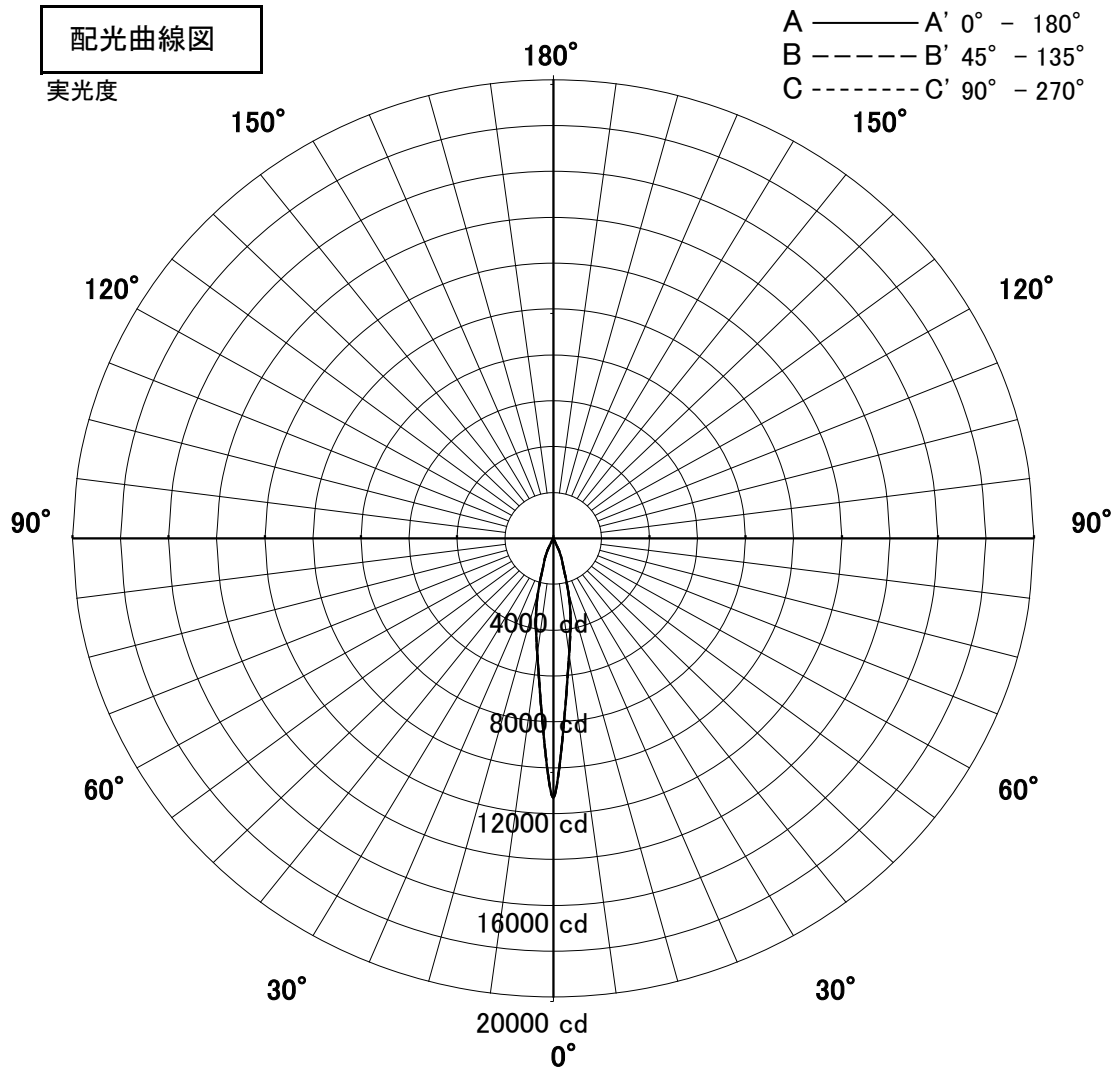

1/2照度角

直射水平面照度

単位: Lx

器具効率	49.1%	
色温度	3000K	
演色評価指数	Ra83	
保守率	良	0.67
	中	0.63
	否	0.56
1/2照度角		
A-A'	15.5	Deg
C-C'	15.5	Deg
最大取付間隔		
A-A'	0.27	H
C-C'	0.27	H

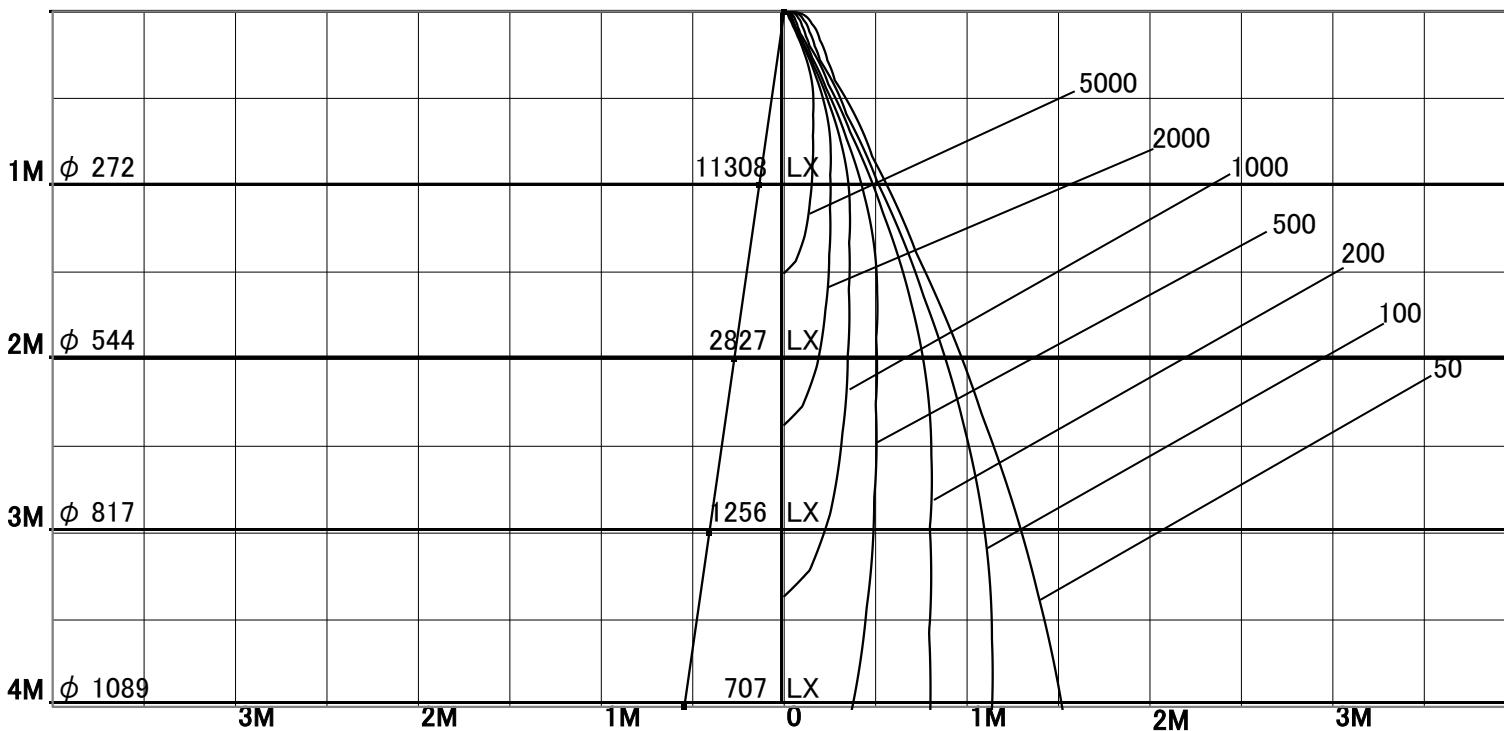

固有照明率表

天井	80%				70%				50%				30%				0%
	70%	50%	30%	10%	70%	50%	30%	10%	70%	50%	30%	10%	70%	50%	30%	10%	0%
壁	10%																0%
床	10%																0%
0.60	82	77	73	71	81	76	73	71	80	76	73	71	79	75	72	70	70
0.80	86	81	78	75	85	81	78	75	84	80	77	75	83	79	77	75	74
1.00	90	85	82	80	89	85	82	80	88	84	81	79	86	83	81	79	78
1.25	93	89	86	84	92	88	85	83	90	87	85	83	89	86	84	82	81
1.50	94	91	88	86	94	90	88	86	92	89	87	85	90	88	86	85	83
2.00	97	95	93	91	97	94	92	91	95	93	91	90	93	92	90	89	88
2.50	99	97	96	94	98	97	95	94	97	95	94	93	95	94	93	92	90
3.00	100	99	98	97	100	98	97	96	98	97	96	95	96	95	95	94	92
4.00	102	101	100	99	101	100	99	98	99	98	98	97	97	97	96	96	94
5.00	102	102	101	100	101	101	100	100	99	99	99	98	98	97	97	97	95
7.00	103	103	102	102	102	102	102	101	100	100	100	100	98	98	98	98	96
10.00	103	103	103	103	102	102	102	102	101	101	101	101	99	99	99	99	97