

屋内照明器具特性

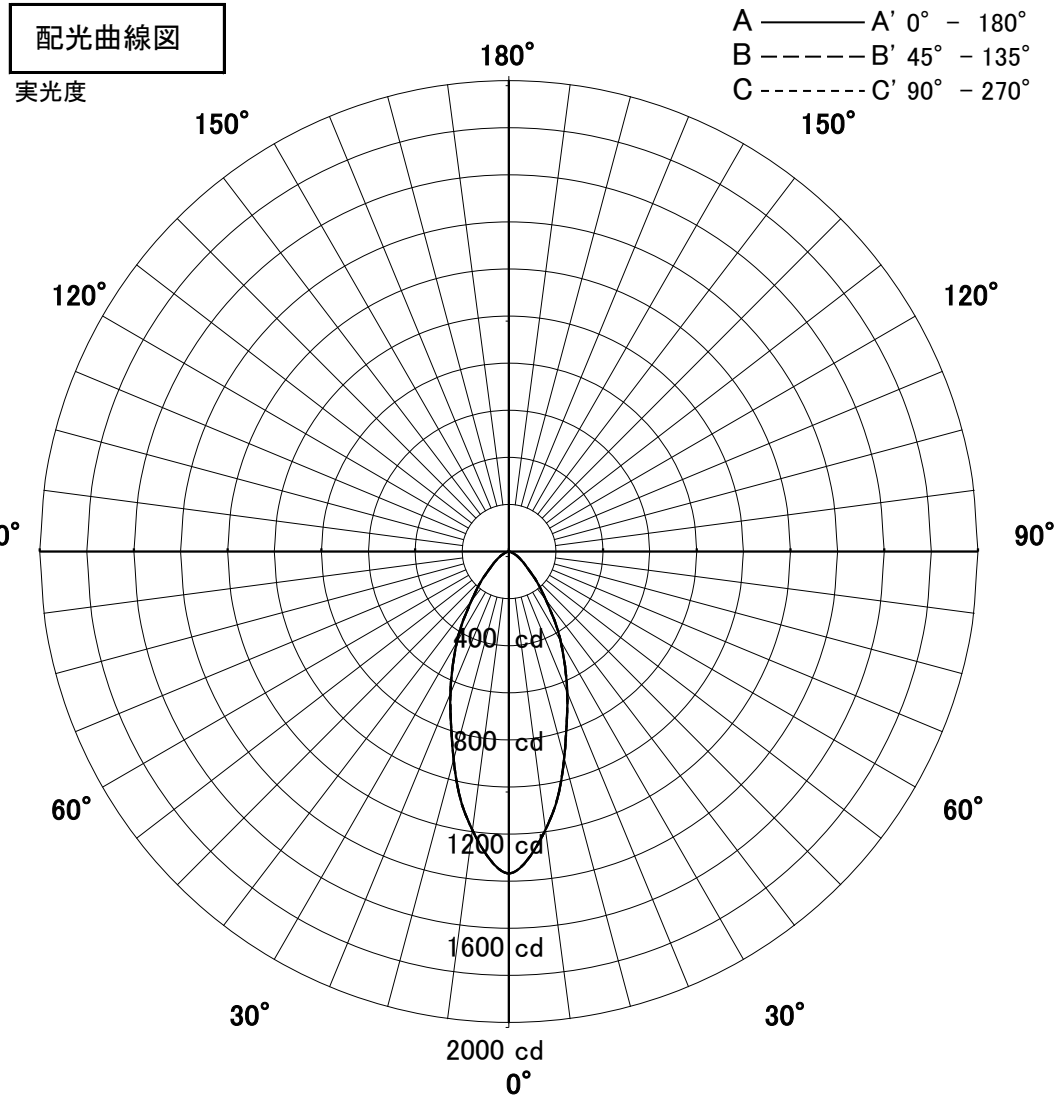

品名	DD-3219-W		
光源	LECF/16W-M11GHP40		
実効光束 (器具光束)	1058lm	効率	67lm/W

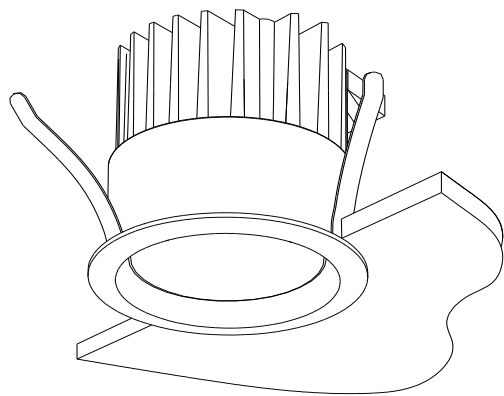

1/2照度角

直射水平面照度

単位:Lx

色温度	4000K	
演色評価指数	Ra80	
保守率	良	0.8
	中	0.6
	否	0.54

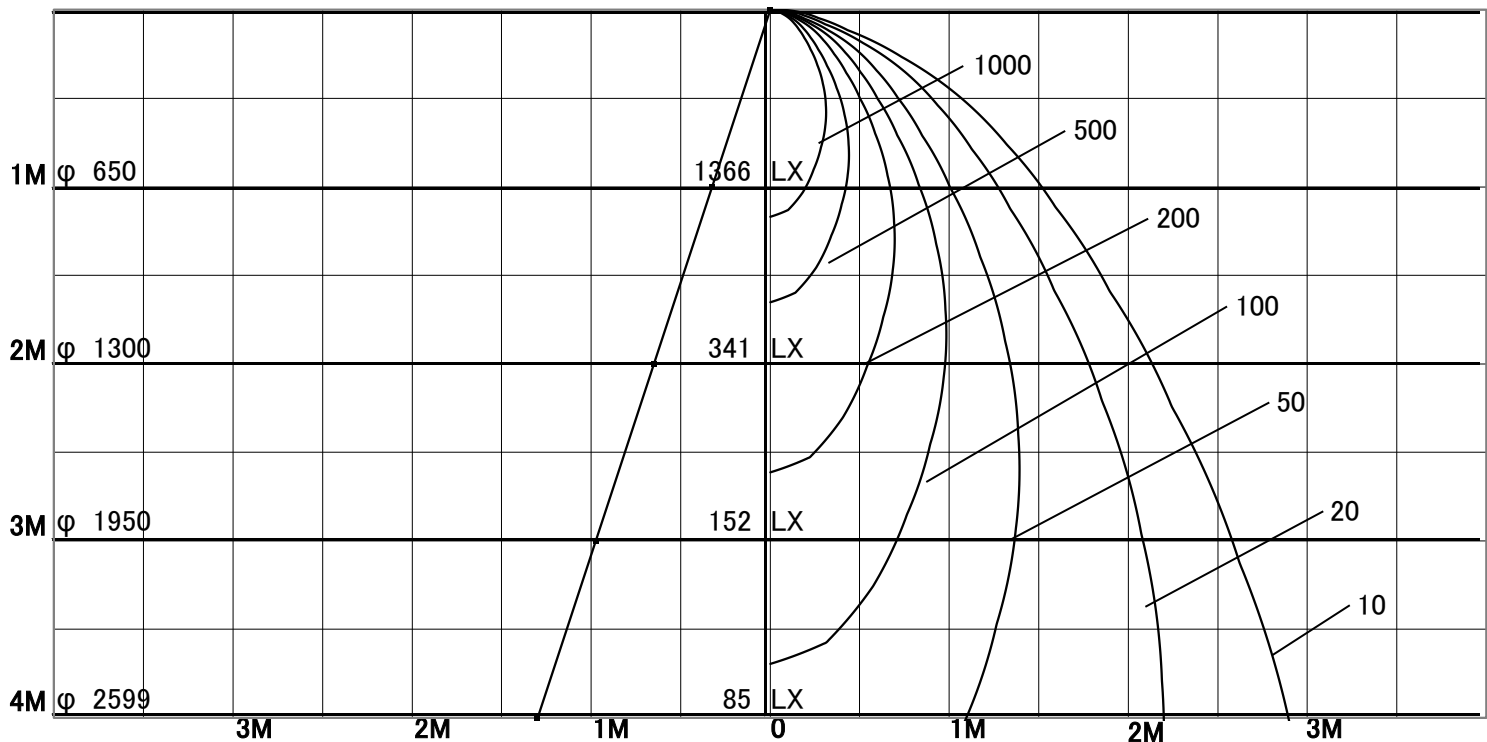

照明率表

天井	80%				70%				50%				30%				0%
	70%	50%	30%	10%	70%	50%	30%	10%	70%	50%	30%	10%	70%	50%	30%	10%	
壁	10%																
床	10%																
0.60	70	62	57	54	69	62	57	54	67	61	57	54	66	60	56	53	52
0.80	76	69	64	61	75	69	64	61	73	68	63	60	72	67	63	60	59
1.00	81	75	70	67	80	74	70	67	78	73	69	66	77	72	69	66	64
1.25	85	80	76	72	84	79	75	72	82	78	74	72	80	77	74	71	70
1.50	88	83	79	76	87	83	79	76	85	81	78	75	83	80	77	75	73
2.00	92	88	85	83	91	88	85	82	89	86	84	81	87	85	83	81	79
2.50	95	92	89	87	94	91	88	86	91	89	87	85	90	88	86	84	83
3.00	96	94	92	90	95	93	91	89	93	91	90	88	91	90	88	87	85
4.00	98	96	94	93	97	95	94	92	95	93	92	91	93	92	91	90	88
5.00	99	97	96	95	98	96	95	94	96	95	93	93	94	93	92	91	89
7.00	100	99	98	97	99	98	97	96	97	96	95	95	95	94	94	93	91
10.00	100	100	99	99	99	99	98	98	97	97	96	96	95	95	95	94	92