

屋内照明器具特性

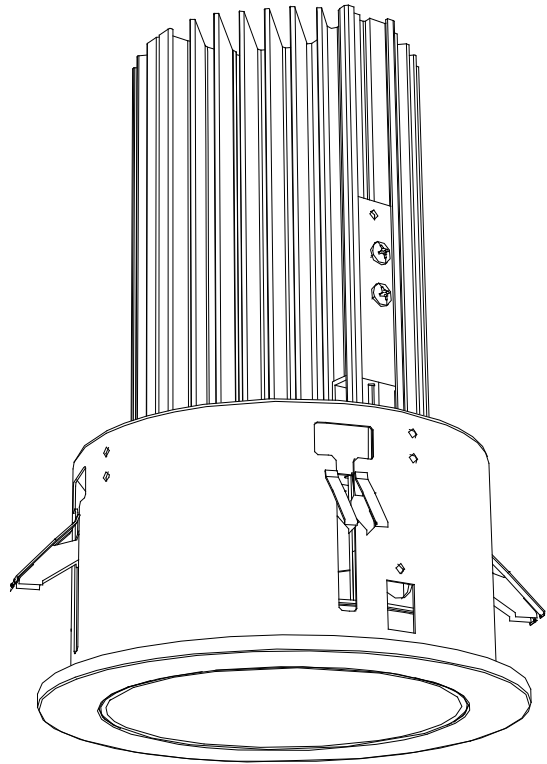

品名	DD-3230-W		
光源	LED63W		
実効光束 (器具光束)	5483lm	エネルギー 効率	87.0lm/W



配光曲線図
実光度

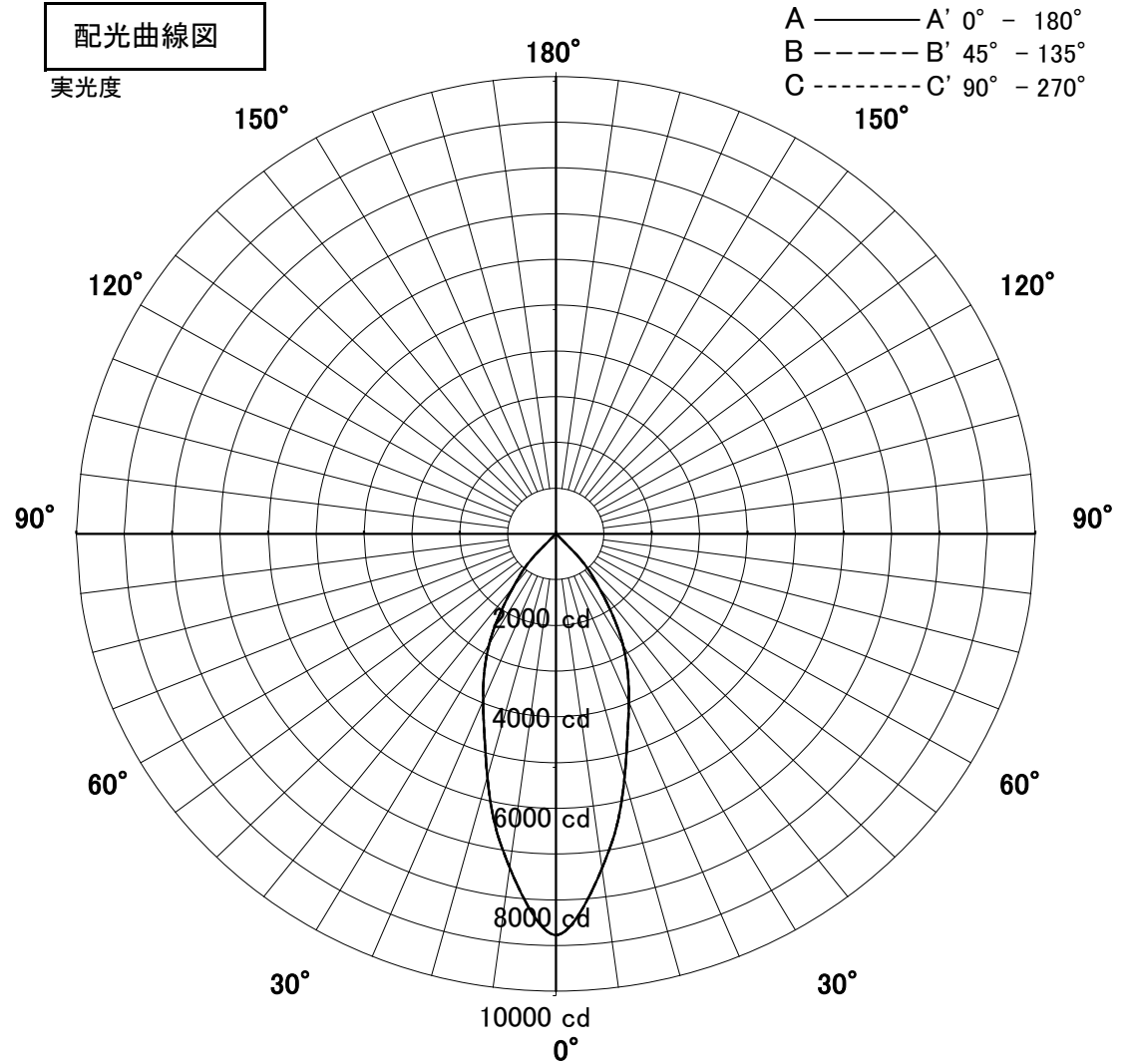

1/2照度角

直射水平面照度

単位: Lx

器具効率	82.2%	
色温度	4000K	
演色評価指数	Ra83	
保守率	良	0.67
	中	0.63
	否	0.56
1/2照度角		
A-A'	34.5	Deg
C-C'	34.5	Deg
最大取付間隔		
A-A'	0.62	H
C-C'	0.62	H

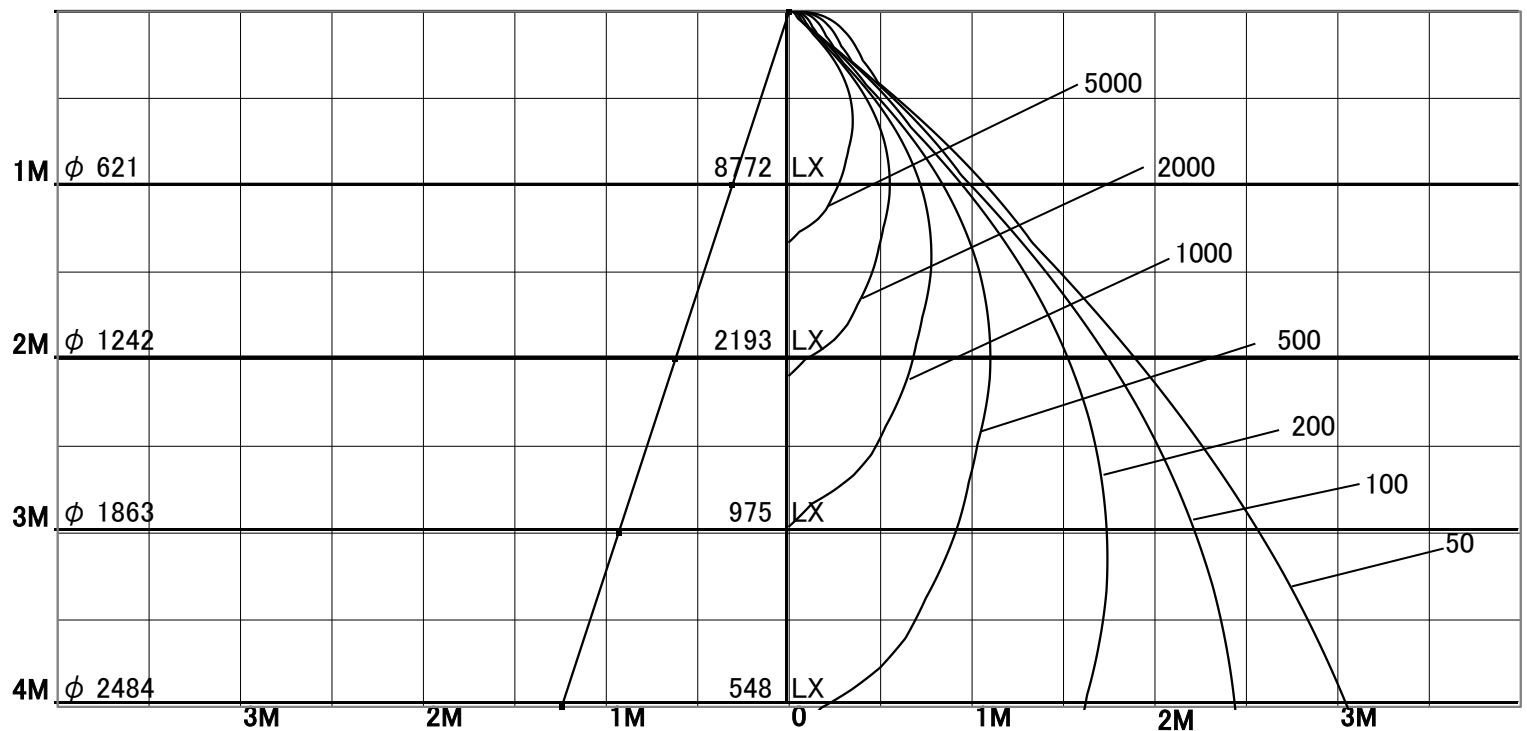

固有照明率表

天井	80%				70%				50%				30%				0%
	70%	50%	30%	10%	70%	50%	30%	10%	70%	50%	30%	10%	70%	50%	30%	10%	0%
壁	10%																0%
床	10%																0%
0.60	84	77	73	70	83	77	73	70	82	76	73	70	81	76	72	70	69
0.80	90	83	79	76	89	83	79	76	87	82	79	76	86	81	78	76	74
1.00	94	89	85	82	93	88	85	82	91	87	84	81	90	86	83	81	80
1.25	98	93	89	87	97	92	89	86	95	91	88	86	93	90	87	85	84
1.50	100	96	93	90	99	95	92	90	97	94	91	89	95	93	90	88	87
2.00	103	100	98	96	102	100	97	95	100	98	96	95	99	97	95	94	92
2.50	106	103	101	100	104	102	101	99	103	101	99	98	101	99	98	97	95
3.00	107	105	104	102	106	104	103	102	104	103	101	100	102	101	100	99	97
4.00	108	107	106	105	107	106	105	104	105	104	103	103	103	103	102	101	99
5.00	109	108	107	106	108	107	106	106	106	105	105	104	104	103	103	102	100
7.00	110	109	109	108	109	108	108	107	107	106	106	106	105	105	104	104	101
10.00	110	110	110	110	109	109	109	109	107	107	107	107	105	105	105	105	102