

# 屋内照明器具特性

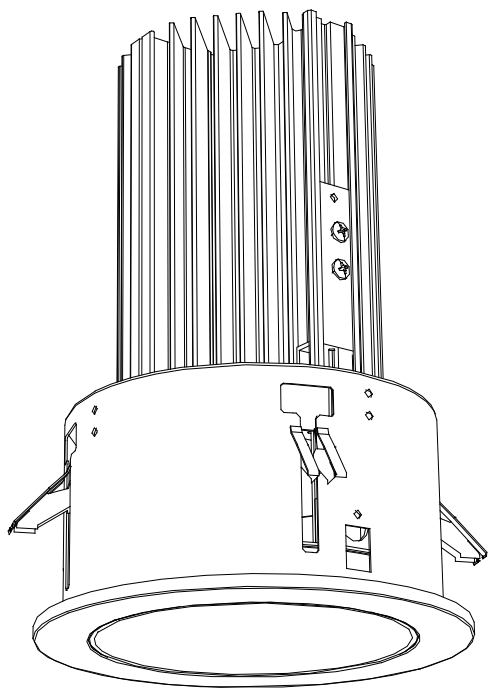

品名	DD-3239-L		
光源	LED63W		
実効光束 (器具光束)	4863lm	エネルギー 効率	77.2lm/W



配光曲線図  
実光度

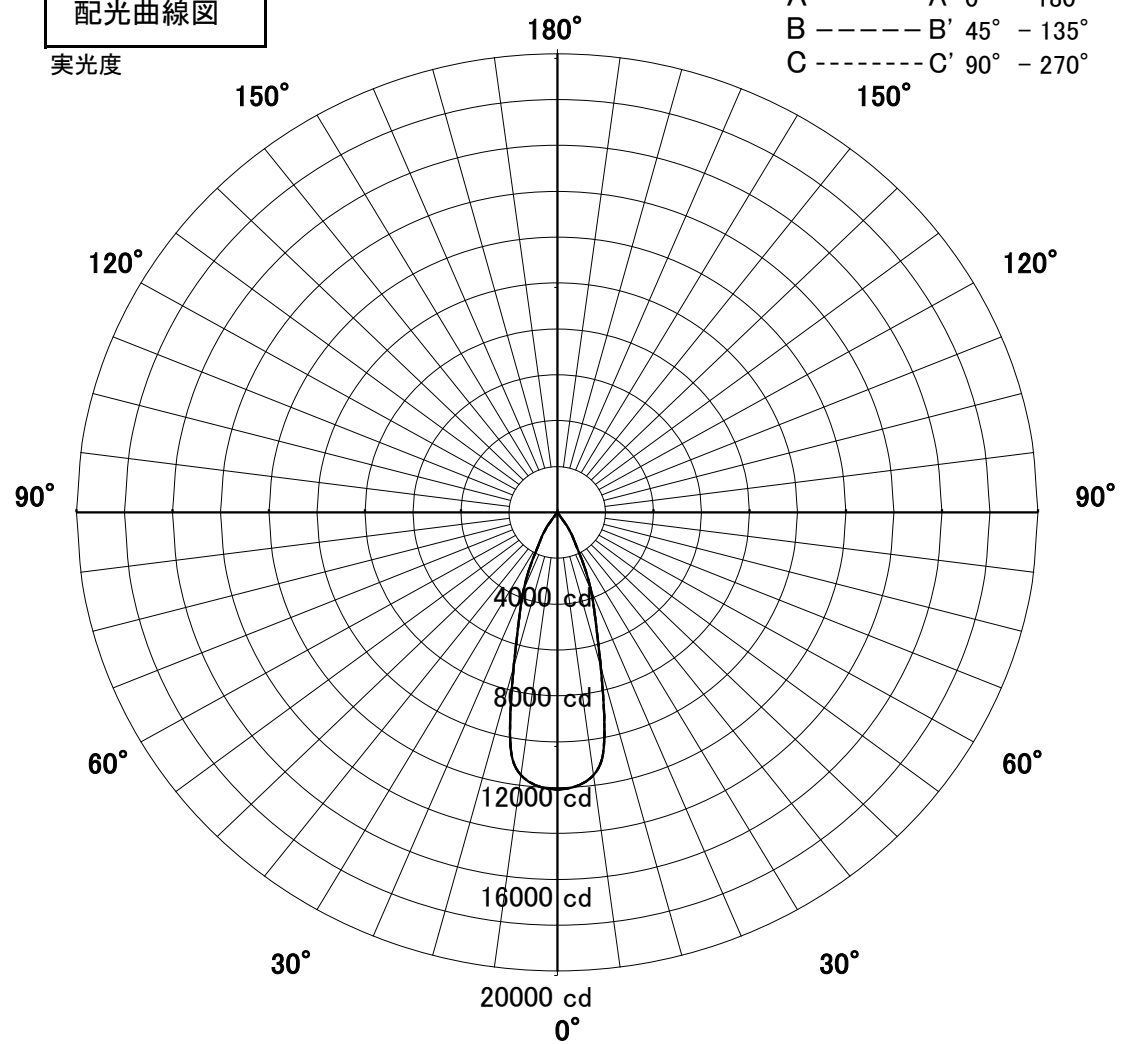

1/2照度角

直射水平面照度

単位: Lx

器具効率	75.3%	
色温度	3000K	
演色評価指数	Ra83	
保守率	良	0.69
	中	0.67
	否	0.63
1/2照度角		
A-A'	32.5	Deg
C-C'	32.5	Deg
最大取付間隔		
A-A'	0.58	H
C-C'	0.58	H

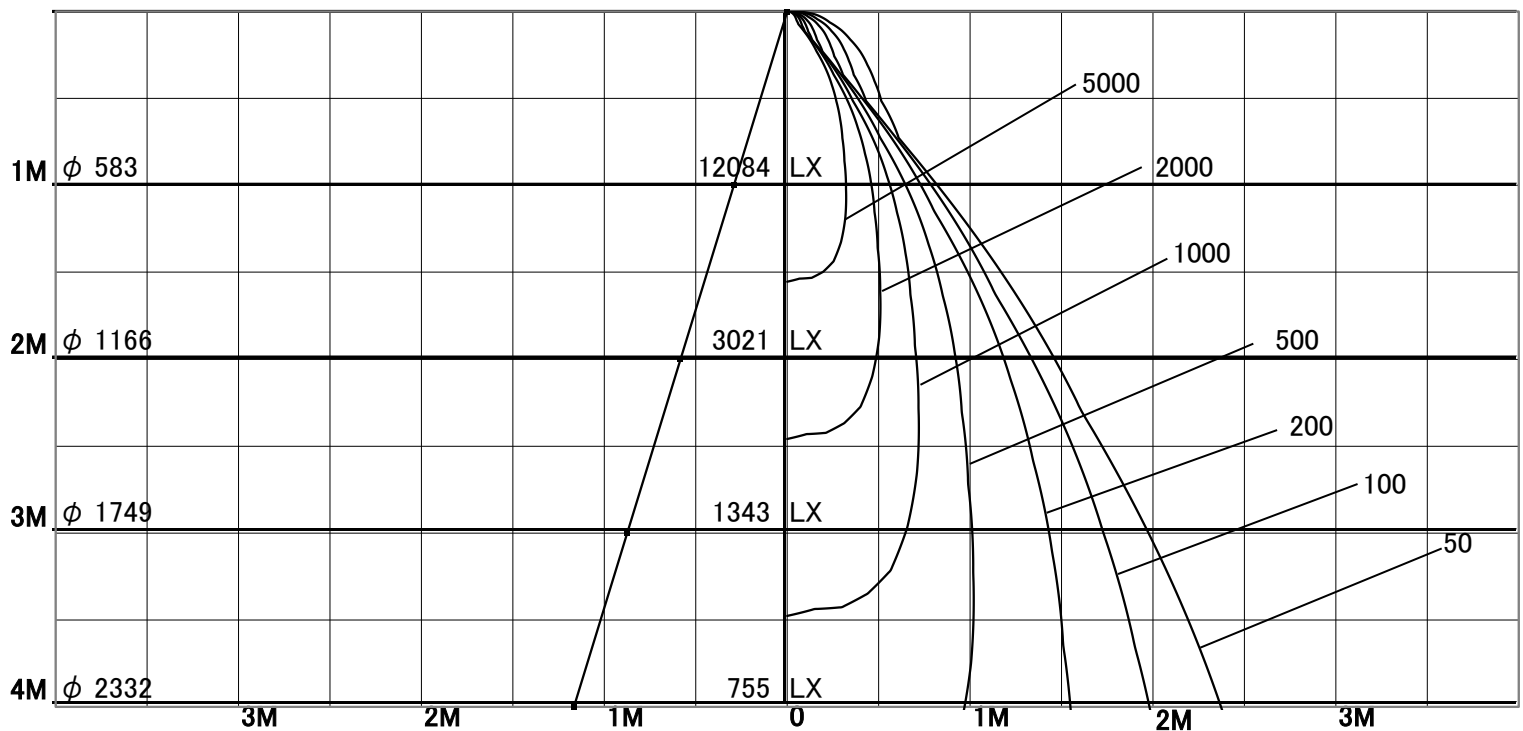

固有照明率表

	80%				70%				50%				30%				0%
	70%	50%	30%	10%	70%	50%	30%	10%	70%	50%	30%	10%	70%	50%	30%	10%	0%
天井	10%																0%
壁	10%																0%
床	10%																0%
0.60	88	82	78	76	87	82	78	76	86	81	78	76	85	80	78	75	74
0.80	93	87	83	81	92	87	83	81	90	86	83	80	89	85	82	80	79
1.00	97	92	88	86	96	91	88	86	94	90	87	85	93	89	87	85	84
1.25	100	95	92	90	99	95	92	90	97	94	91	89	95	92	90	88	87
1.50	102	98	95	93	101	97	95	92	99	96	94	92	97	95	93	91	90
2.00	105	102	100	98	104	101	99	98	102	100	98	97	100	99	97	96	94
2.50	107	105	103	102	106	104	102	101	104	102	101	100	102	101	100	99	97
3.00	108	107	105	104	107	106	105	104	105	104	103	102	104	103	102	101	99
4.00	109	108	107	107	108	107	107	106	106	106	105	104	105	104	104	103	101
5.00	110	109	109	108	109	108	108	107	107	107	106	106	105	105	105	104	102
7.00	111	111	110	110	110	110	109	109	108	108	108	107	106	106	106	106	103
10.00	111	111	111	111	110	110	110	110	108	108	108	108	106	106	106	107	104