

屋内照明器具特性

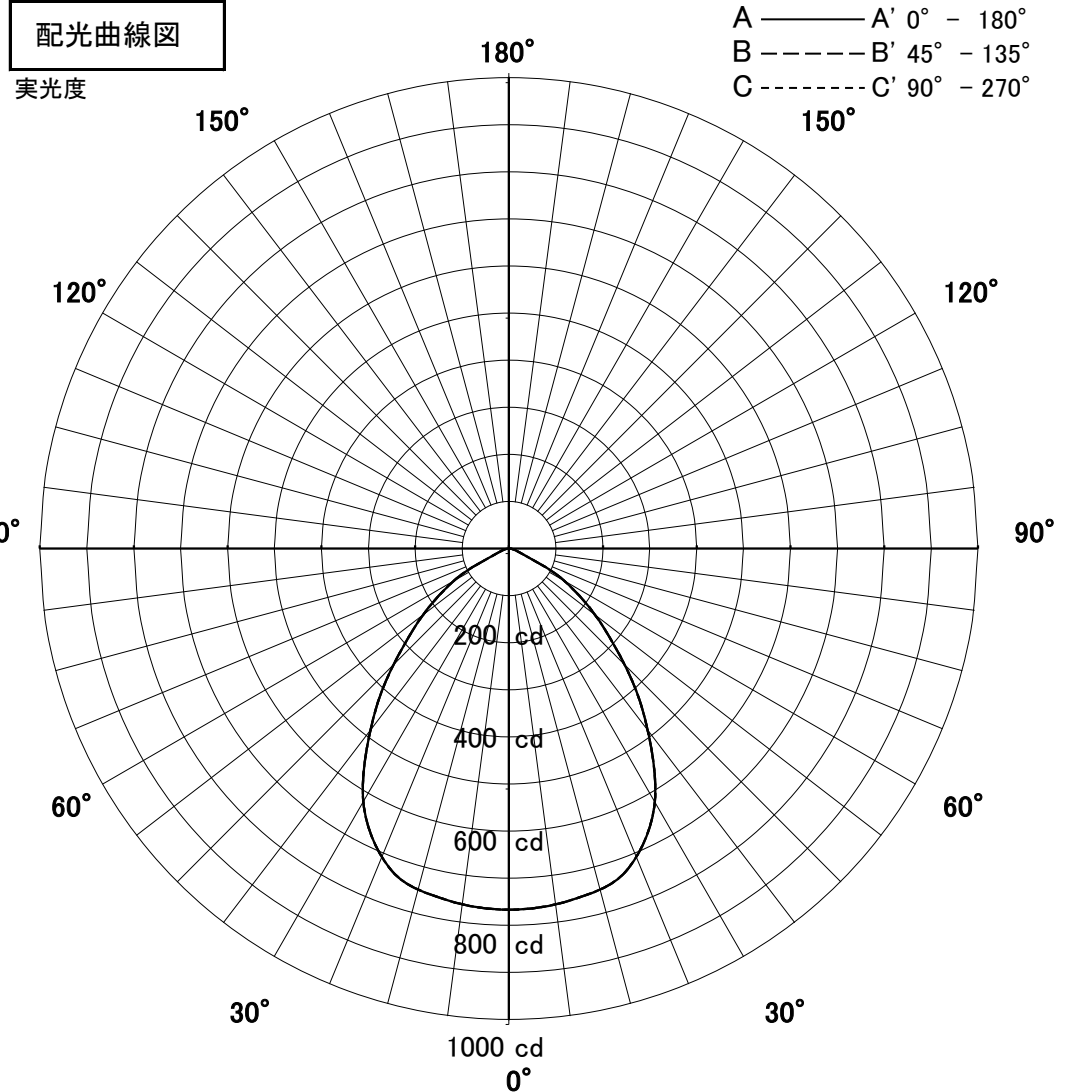

品名	DD-3248-L		
光源	LECF/24L-W15GHP30		
実効光束 (器具光束)	1473lm	効率	60lm/W

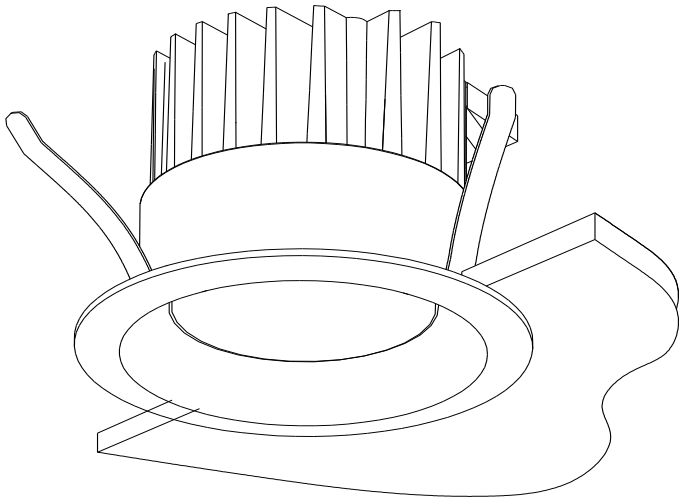

1/2照度角

直射水平面照度

単位:Lx

色温度	3000K	
演色評価指数	Ra80	
保守率	良	0.8
	中	0.6
	否	0.54

1/2照度角		
A-A'	61.5	Deg
C-C'	61.5	Deg
最大取付間隔		
A-A'	1.19	H
C-C'	1.19	H

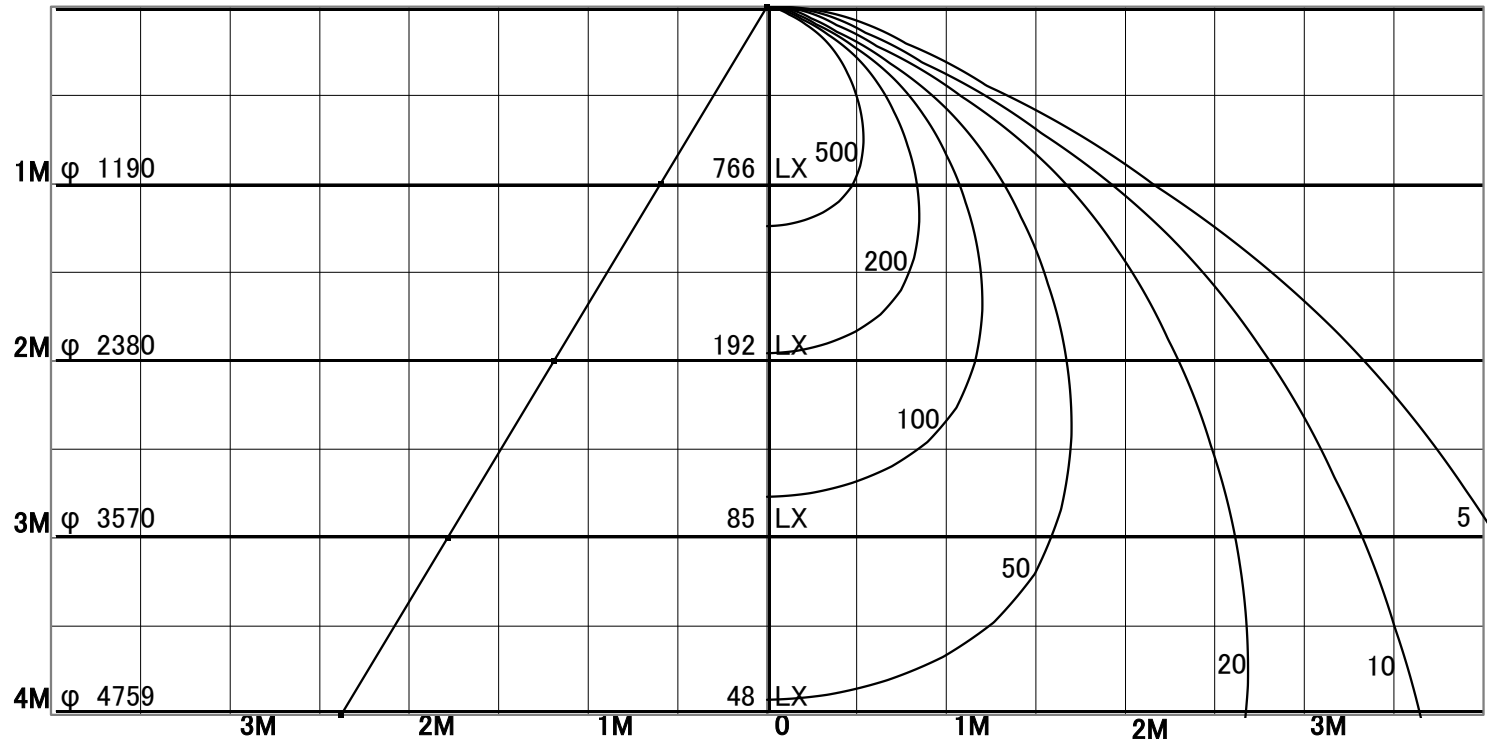

照明率表

天井	80%				70%				50%				30%				0%
	70%	50%	30%	10%	70%	50%	30%	10%	70%	50%	30%	10%	70%	50%	30%	10%	
壁	10%																
床	10%																
0.60	66	56	49	45	64	55	49	45	62	54	49	44	61	53	48	44	43
0.80	74	65	59	54	73	64	58	54	71	63	58	54	69	62	57	53	52
1.00	81	72	66	62	79	71	66	61	77	70	65	61	75	69	64	61	59
1.25	86	79	73	69	85	78	73	69	82	76	72	68	80	75	71	68	66
1.50	90	83	78	74	88	82	78	74	86	81	77	73	83	79	76	73	71
2.00	95	90	85	82	93	89	85	82	91	87	84	81	89	85	82	80	78
2.50	98	93	90	87	96	92	89	86	94	91	88	85	92	89	87	85	82
3.00	99	96	93	90	98	95	92	90	96	93	91	89	94	91	89	88	85
4.00	102	99	96	94	100	98	96	94	98	96	94	92	96	94	92	91	89
5.00	103	100	98	97	101	99	98	96	99	97	96	94	97	96	94	93	91
7.00	104	102	101	99	103	101	100	99	100	99	98	97	98	97	96	95	93
10.00	105	104	103	101	104	103	102	101	101	100	100	99	99	98	98	97	94