

屋内照明器具特性

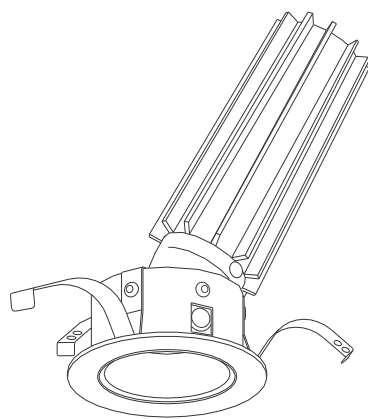

品名	DD-3315-L		
光源	LED_7.2W		
実効光束 (器具光束)	295lm	効率	41.0lm/W



配光曲線図
cd/1000lm

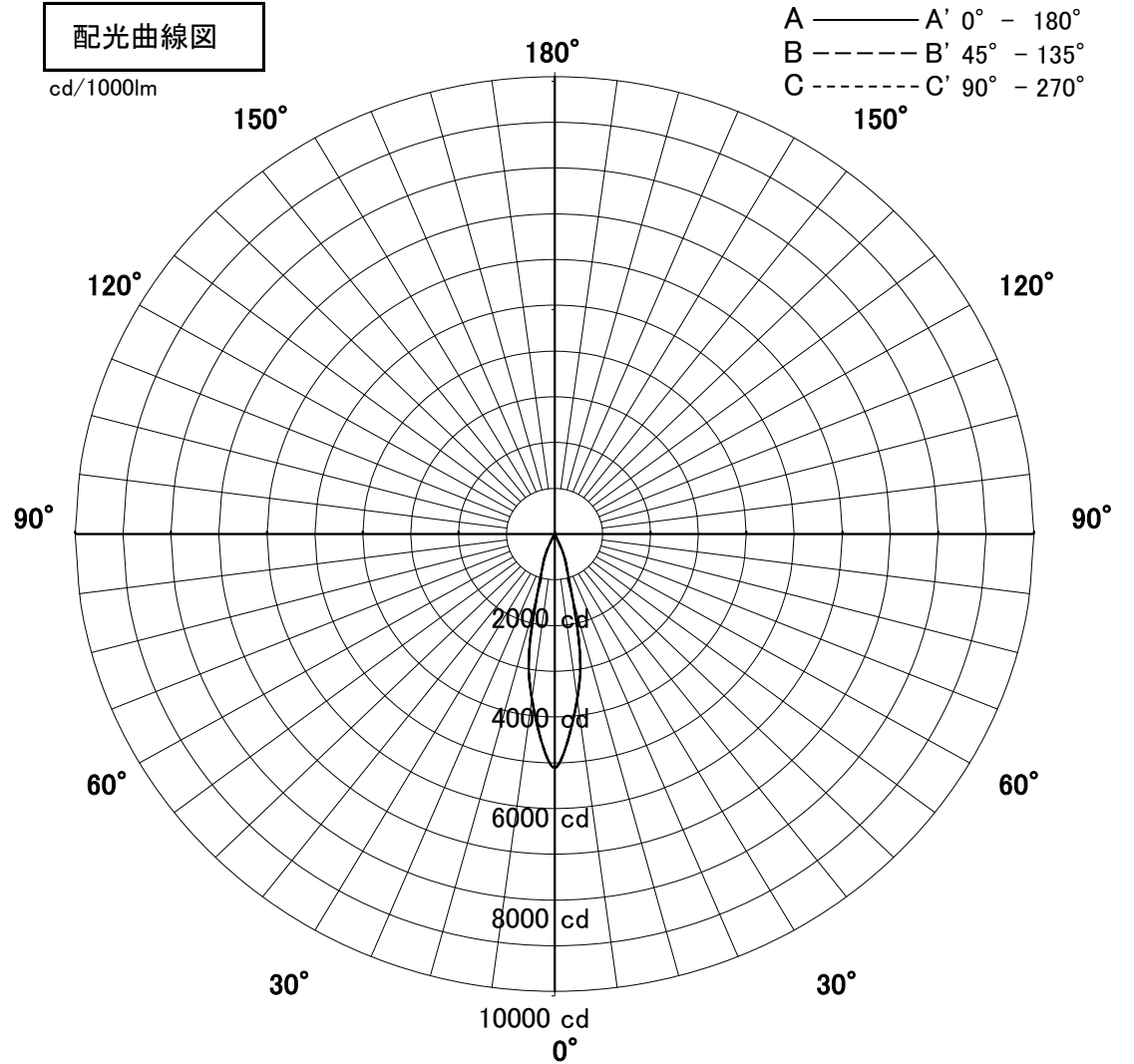

1/2照度角

直射水平面照度

単位:Lx

色温度	3000K	
演色評価指数	Ra80	
保守率	良	0.8
	中	0.6
	否	0.54

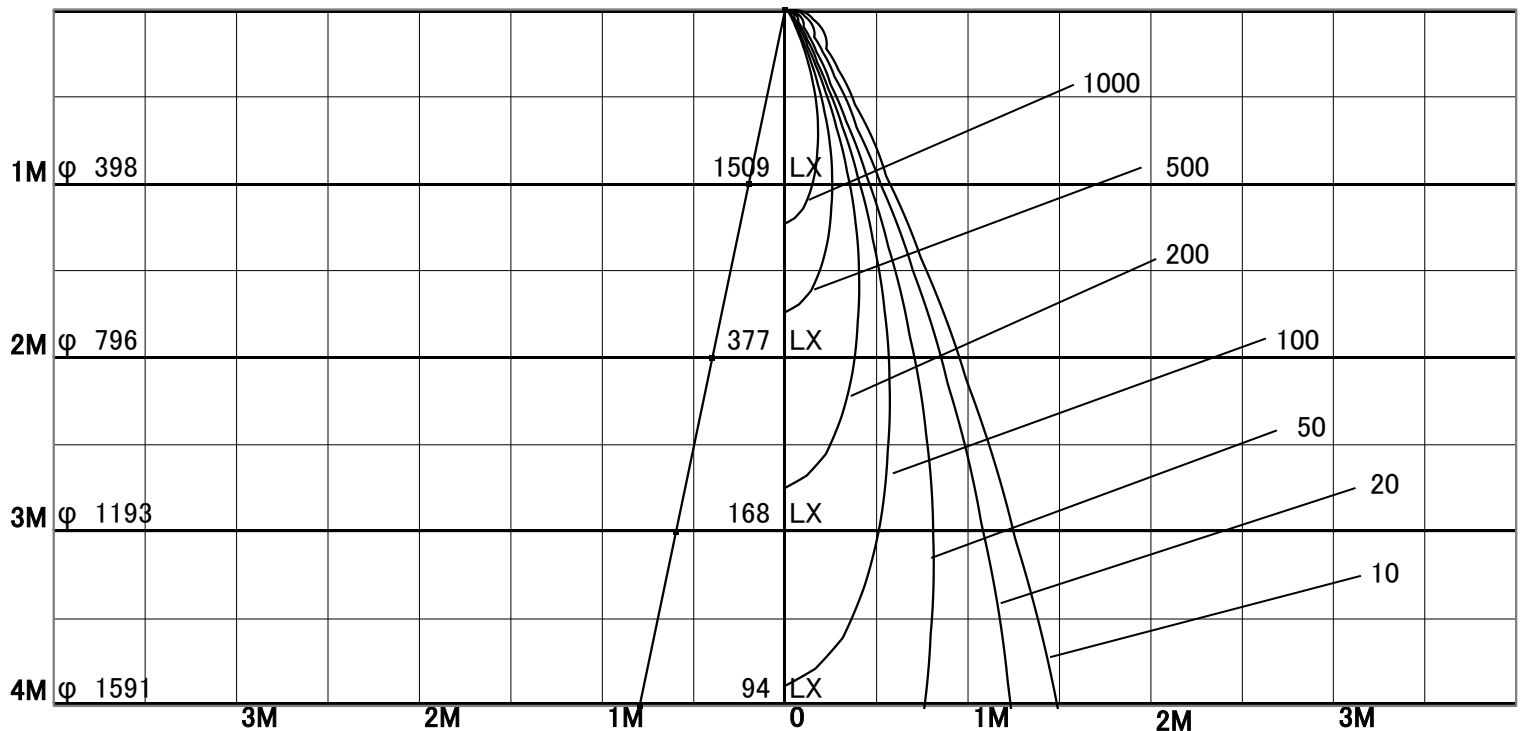

照明率表

	80%				70%				50%				30%				0%
	70%	50%	30%	10%	70%	50%	30%	10%	70%	50%	30%	10%	70%	50%	30%	10%	0%
天井	10%																0%
壁	10%																0%
床	10%																0%
0.60	70	65	62	60	69	65	62	60	68	64	62	60	67	64	61	60	59
0.80	73	69	66	64	73	69	66	64	71	68	65	64	70	67	65	63	62
1.00	76	73	70	68	76	72	70	68	74	71	69	67	73	71	69	67	66
1.25	79	76	73	71	78	75	73	71	77	74	72	70	75	73	71	70	69
1.50	80	78	75	73	80	77	75	73	78	76	74	73	77	75	73	72	71
2.00	83	81	79	78	82	80	79	77	81	79	78	77	79	78	77	76	74
2.50	85	83	82	80	84	82	81	80	82	81	80	79	81	80	79	78	77
3.00	86	84	83	82	85	84	83	82	83	82	82	81	82	81	81	80	79
4.00	87	86	85	84	86	85	84	84	84	84	83	83	83	82	82	82	80
5.00	87	87	86	86	86	86	85	85	85	84	84	84	83	83	83	83	81
7.00	88	88	87	87	87	87	87	86	85	85	85	85	84	84	84	84	82
10.00	88	88	88	88	87	87	87	87	86	86	86	86	84	84	84	84	82