

屋内照明器具特性

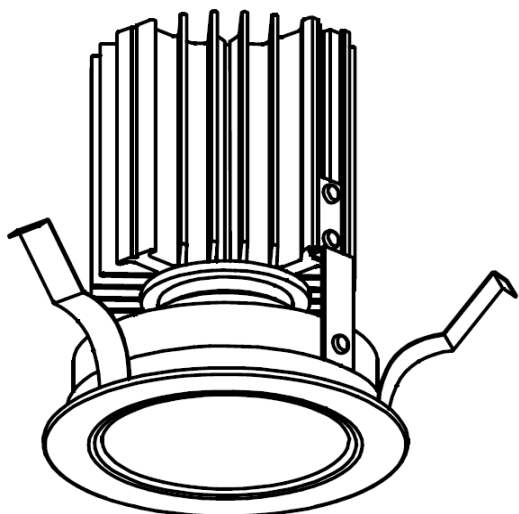

品名	DD-3345-L		
光源	LED30W		
実効光束 (器具光束)	2496lm	エネルギー 効率	83.2lm/W



配光曲線図
実光度

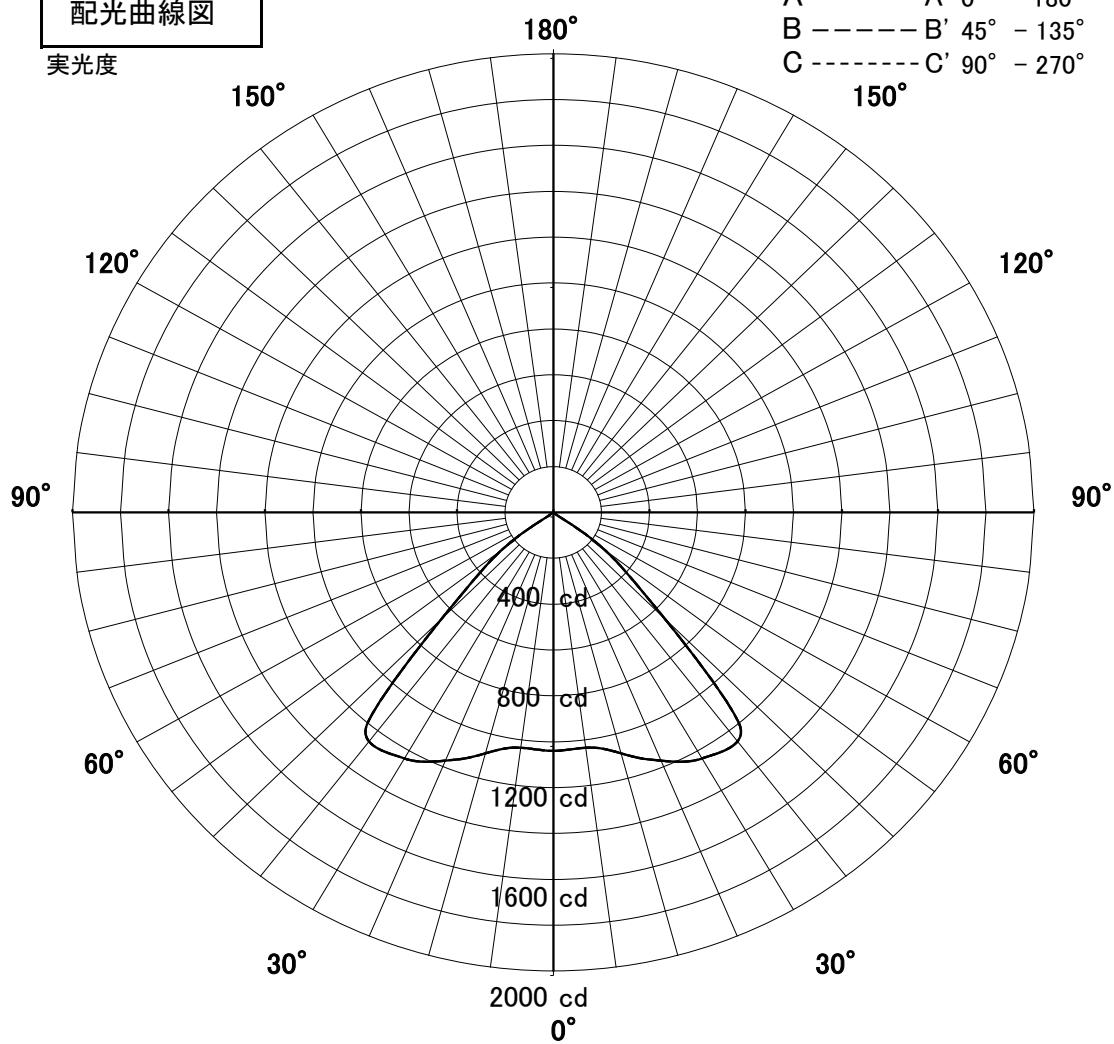

1/2照度角

直射水平面照度

単位: Lx

器具効率	83.4%	
色温度	3000K	
演色評価指数	Ra83	
保守率	良	0.67
	中	0.63
	否	0.56
1/2照度角		
A-A'	81.0	Deg
C-C'	81.0	Deg
最大取付間隔		
A-A'	1.71	H
C-C'	1.71	H

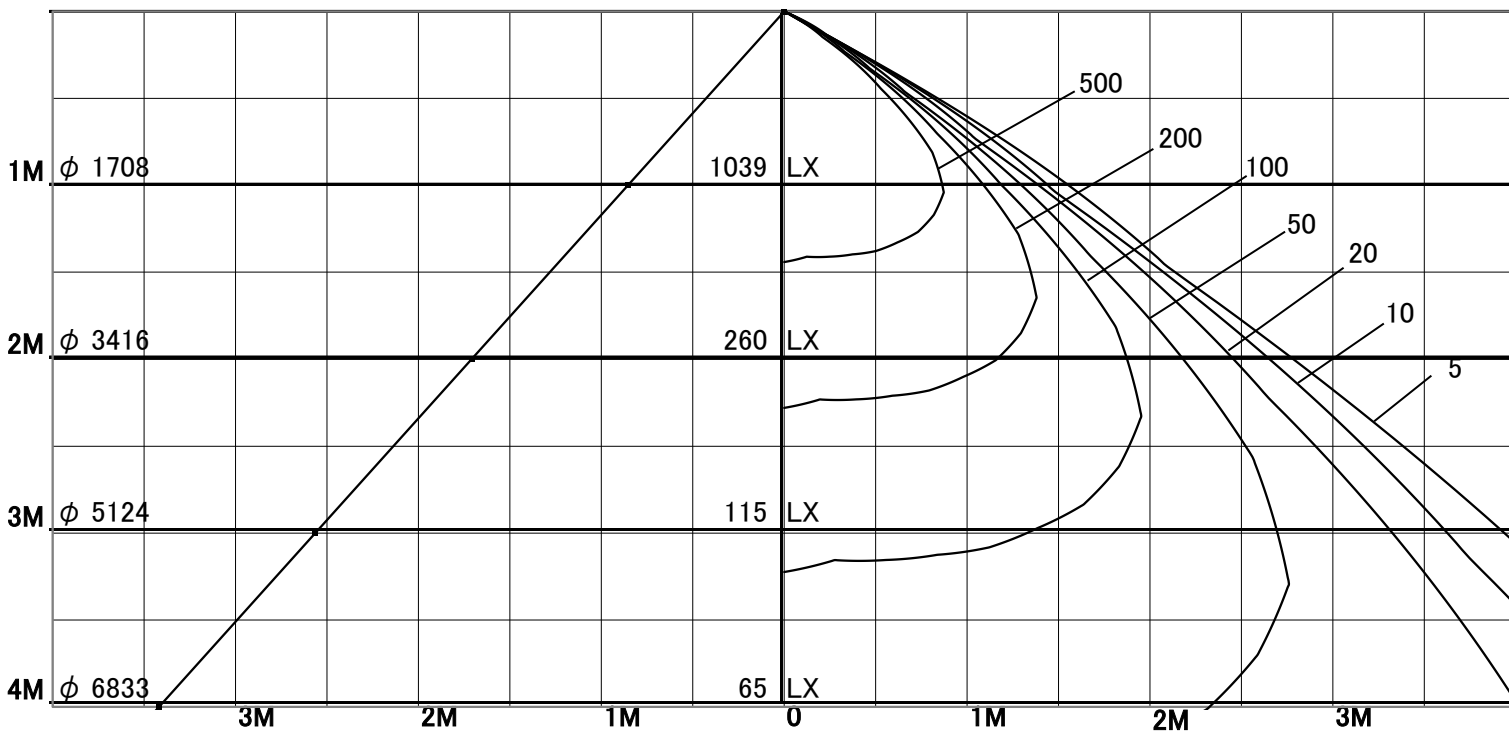

固有照明率表

	80%				70%				50%				30%				0%
	70%	50%	30%	10%	70%	50%	30%	10%	70%	50%	30%	10%	70%	50%	30%	10%	0%
天井	10%																0%
壁	10%																0%
床	10%																0%
0.60	71	62	56	52	70	61	56	52	68	60	55	52	66	60	55	51	50
0.80	80	71	65	61	78	71	65	61	76	70	65	61	74	68	64	61	59
1.00	86	78	73	69	85	78	73	69	82	77	72	69	80	75	71	68	67
1.25	91	85	80	76	90	84	80	76	88	83	79	76	85	81	78	75	73
1.50	94	89	85	81	93	88	84	81	91	87	83	80	89	85	82	80	78
2.00	99	95	91	89	98	94	91	88	95	92	90	87	93	91	88	86	85
2.50	101	98	95	93	100	97	95	92	98	95	93	91	96	94	92	90	88
3.00	103	100	98	96	102	99	97	95	100	98	96	94	98	96	94	93	91
4.00	105	102	100	99	103	101	100	98	101	100	98	97	99	98	97	95	93
5.00	105	104	102	100	104	103	101	100	102	101	99	98	100	99	98	97	94
7.00	106	105	104	103	105	104	103	102	103	102	101	100	101	100	99	98	96
10.00	107	106	105	104	106	105	104	103	103	103	102	101	101	101	100	99	97