

屋内照明器具特性

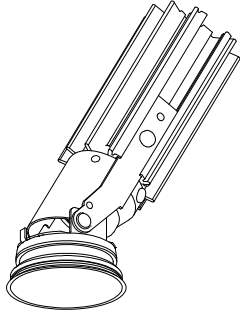

品名	DD-3499-LL		
光源	LED10.3W		
実効光束 (器具光束)	408lm	効率	39.6lm/W



配光曲線図

実光度

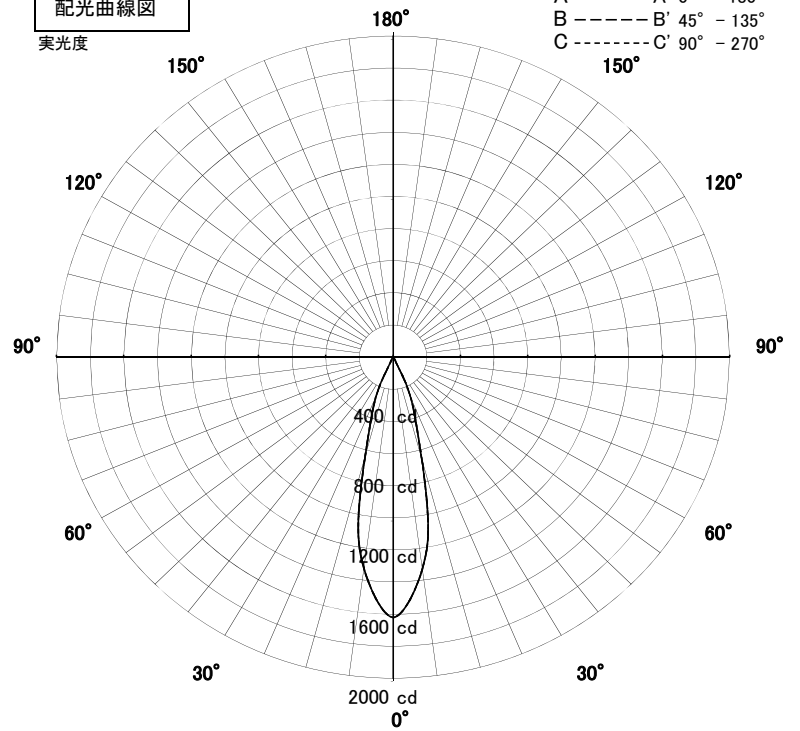

1/2照度角

直射水平面照度

単位:Lx

色温度	2700K	
演色評価指数	Ra82	
保守率	良	0.67
	中	0.63
	否	0.56

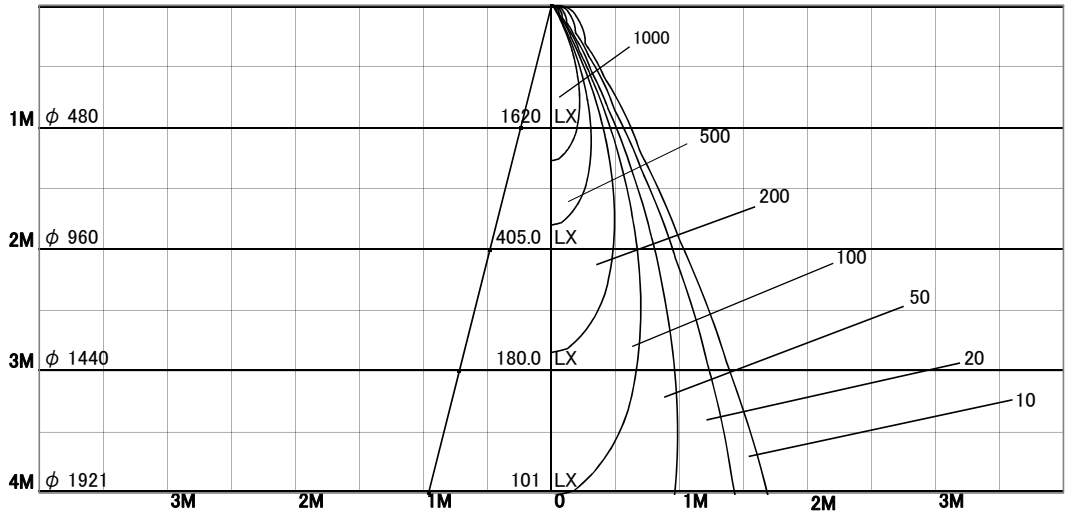

1/2照度角		
A-A'	27.0	Deg
C-C'	27.0	Deg
最大取付間隔		
A-A'	0.48	H
C-C'	0.48	H

照明率表

天井	80%				70%				50%				30%				0%
	70%	50%	30%	10%	70%	50%	30%	10%	70%	50%	30%	10%	70%	50%	30%	10%	0%
壁	10%																0%
床	10%																0%
0.60	88	83	79	76	88	82	79	76	86	82	79	76	85	81	78	76	75
0.80	93	88	84	81	92	87	84	81	91	86	83	81	89	86	83	81	79
1.00	97	92	89	86	96	92	89	86	95	91	88	86	93	90	87	85	84
1.25	100	96	93	90	99	95	92	90	97	94	92	90	96	93	91	89	88
1.50	102	98	96	93	101	98	95	93	99	96	94	92	98	95	93	92	90
2.00	105	103	100	99	104	102	100	98	102	100	99	97	101	99	98	96	95
2.50	107	105	103	102	106	104	103	101	104	103	102	100	103	101	100	99	98
3.00	109	107	106	105	108	106	105	104	106	105	104	103	104	103	102	102	100
4.00	110	109	108	107	109	108	107	106	107	106	105	105	105	104	104	104	101
5.00	110	110	109	109	109	109	108	108	107	107	107	106	106	105	105	105	102
7.00	111	111	111	110	110	110	110	110	108	108	108	108	106	106	106	106	104
10.00	112	112	112	112	111	111	111	111	109	109	109	109	107	107	107	107	104