

屋内照明器具特性

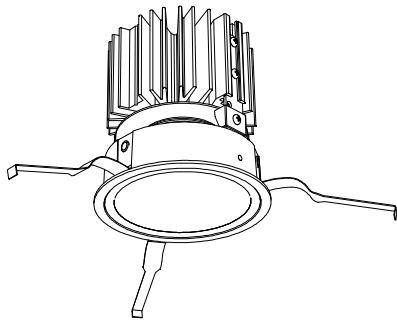

品名	DD-3501-N		
光源	LED27.0W		
実効光束 (器具光束)	3136lm	エネルギー 効率	116.1lm/W



配光曲線図

実光度

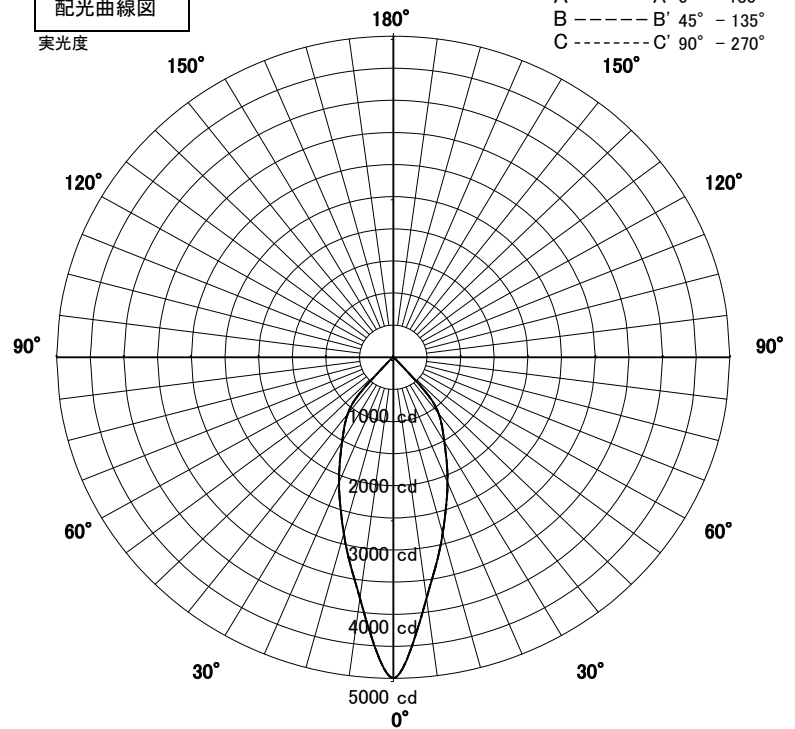

1/2照度角

直射水平面照度

単位:Lx

器具効率	90.0%	
色温度	5000K	
演色評価指数	Ra83	
保守率	良	0.67
	中	0.63
	否	0.56
1/2照度角		
A-A'	30.5	Deg
C-C'	30.5	Deg
最大取付間隔		
A-A'	0.55	H
C-C'	0.55	H

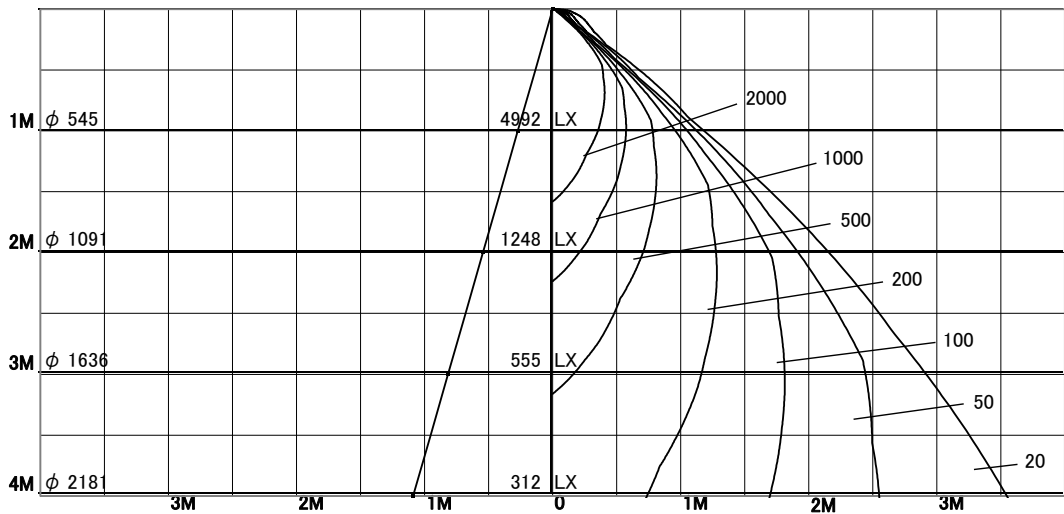

固有照明率表

天井	80%				70%				50%				30%				0%
	70%	50%	30%	10%	70%	50%	30%	10%	70%	50%	30%	10%	70%	50%	30%	10%	0%
壁	10%																
床	10%																
0.60	82	75	70	67	81	74	70	67	80	74	70	67	78	73	70	67	66
0.80	88	81	77	74	87	81	77	74	85	80	76	73	84	79	76	73	72
1.00	93	87	83	80	92	87	83	80	90	85	82	79	88	84	81	79	78
1.25	97	92	88	85	96	91	88	85	94	90	87	84	92	89	86	84	82
1.50	99	95	91	89	98	94	91	88	96	93	90	88	94	91	89	87	86
2.00	103	100	97	95	102	99	96	94	100	97	95	93	98	96	94	93	91
2.50	105	102	100	99	104	102	100	98	102	100	98	97	100	99	97	96	94
3.00	106	104	103	101	105	104	102	101	103	102	101	99	101	100	99	98	96
4.00	108	106	105	104	107	105	104	103	105	104	103	102	103	102	101	100	98
5.00	108	107	106	105	107	106	105	105	105	105	104	103	103	103	102	102	99
7.00	109	109	108	107	108	108	107	107	106	106	105	105	104	104	103	103	101
10.00	110	109	109	109	109	108	108	108	107	106	106	106	105	104	104	104	101