

# 屋内照明器具特性

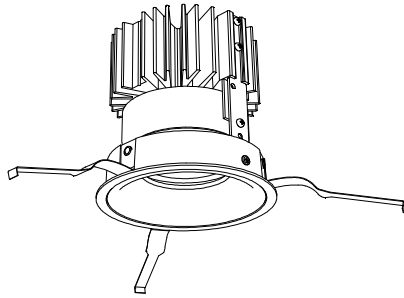

品名	DD-3505-N		
光源	LED27.0W		
実効光束 (器具光束)	2373lm	効率	87.8lm/W



配光曲線図

実光度

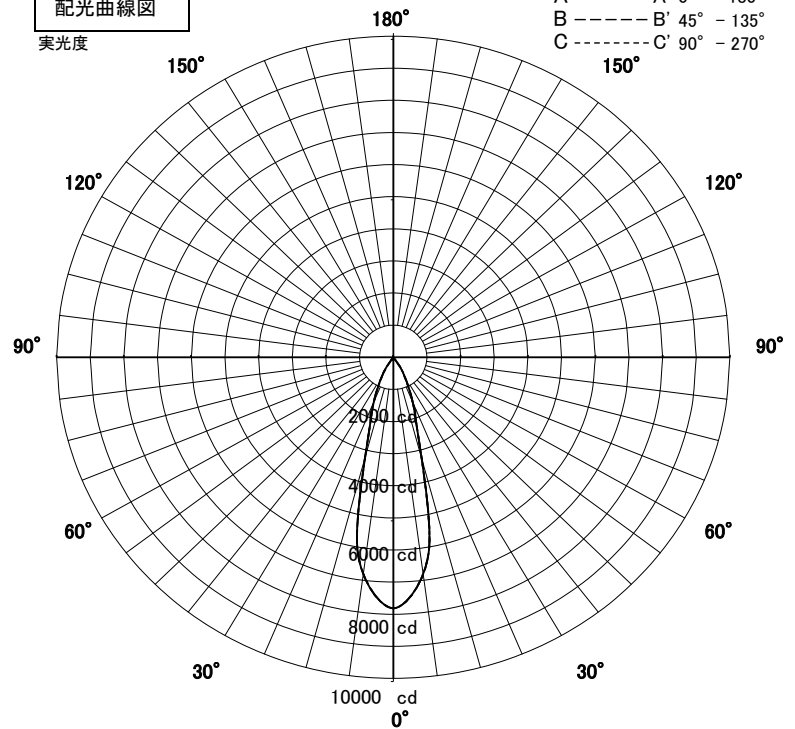

1/2照度角

直射水平面照度

単位:Lx

器具効率	68.5%	
色温度	5000K	
演色評価指数	Ra83	
保守率	良	0.67
	中	0.63
	否	0.56

1/2照度角		
A-A'	26.5	Deg
C-C'	26.5	Deg
最大取付間隔		
A-A'	0.47	H
C-C'	0.47	H

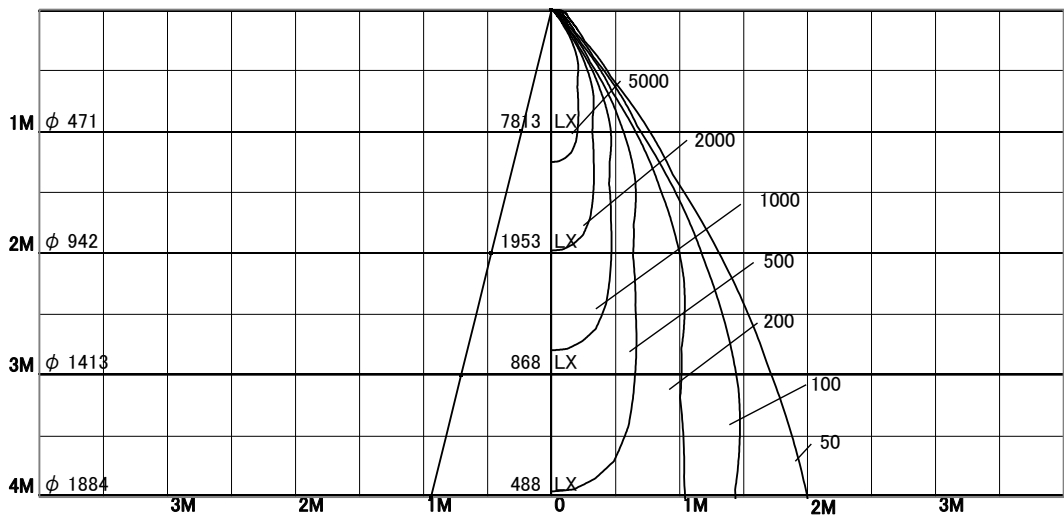

照明率表

	80%				70%				50%				30%				0%
	70%	50%	30%	10%	70%	50%	30%	10%	70%	50%	30%	10%	70%	50%	30%	10%	0%
天井	10%																0%
壁	10%																0%
床	10%																0%
0.60	54	51	49	47	54	51	48	47	53	50	48	47	52	50	48	47	46
0.80	57	54	52	50	57	54	51	50	56	53	51	50	55	53	51	50	49
1.00	60	57	55	53	59	56	54	53	58	56	54	53	57	55	54	53	52
1.25	61	59	57	56	61	59	57	55	60	58	56	55	59	57	56	55	54
1.50	63	60	59	57	62	60	58	57	61	59	58	57	60	58	57	56	55
2.00	65	63	62	61	64	63	61	60	63	62	61	60	62	61	60	59	58
2.50	66	65	64	63	65	64	63	62	64	63	62	62	63	62	62	61	60
3.00	67	66	65	64	66	65	64	64	65	64	64	63	64	63	63	62	61
4.00	67	67	66	66	67	66	66	65	66	65	65	64	64	64	64	64	62
5.00	68	67	67	67	67	67	66	66	66	66	65	65	65	65	64	64	63
7.00	68	68	68	68	68	67	67	67	66	66	66	66	65	65	65	65	64
10.00	69	68	68	68	68	68	68	68	67	67	67	67	65	66	66	66	64