

屋内照明器具特性

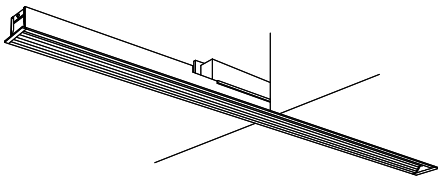

品名	DD-3556-N		
光源	LED51W		
実効光束 (器具光束)	5687lm	効率	111.5lm/W



配光曲線図

実光度

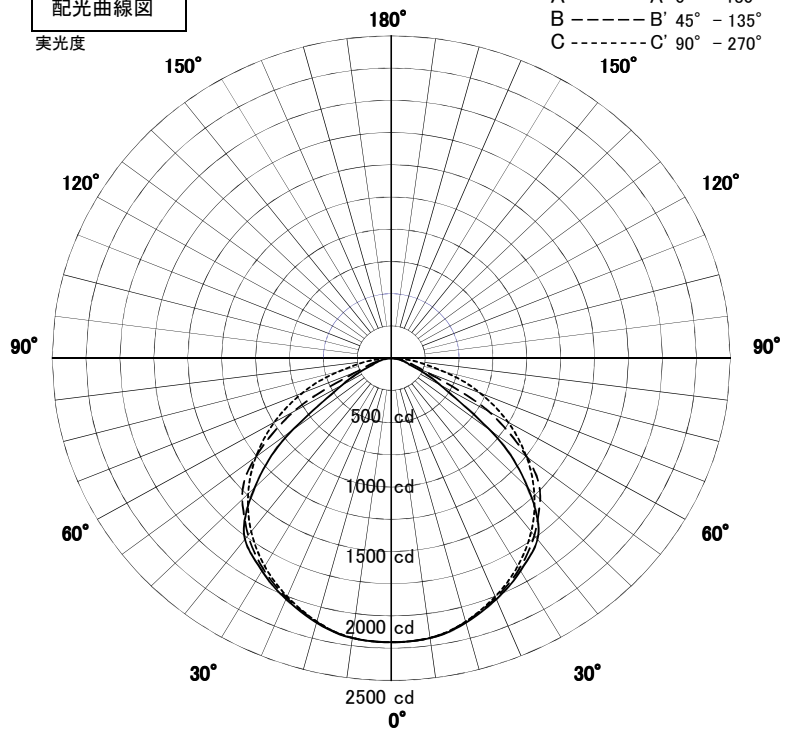

直射水平面照度

単位:Lx

A-A' Section

C-C' Section

色温度	5000K	
演色評価指数	Ra83	
保守率	良	0.63
	中	0.60
	否	0.56
1/2照度角		
A-A'	65.5	Deg
C-C'	64.5	Deg
最大取付間隔		
A-A'	1.29	H
C-C'	1.26	H

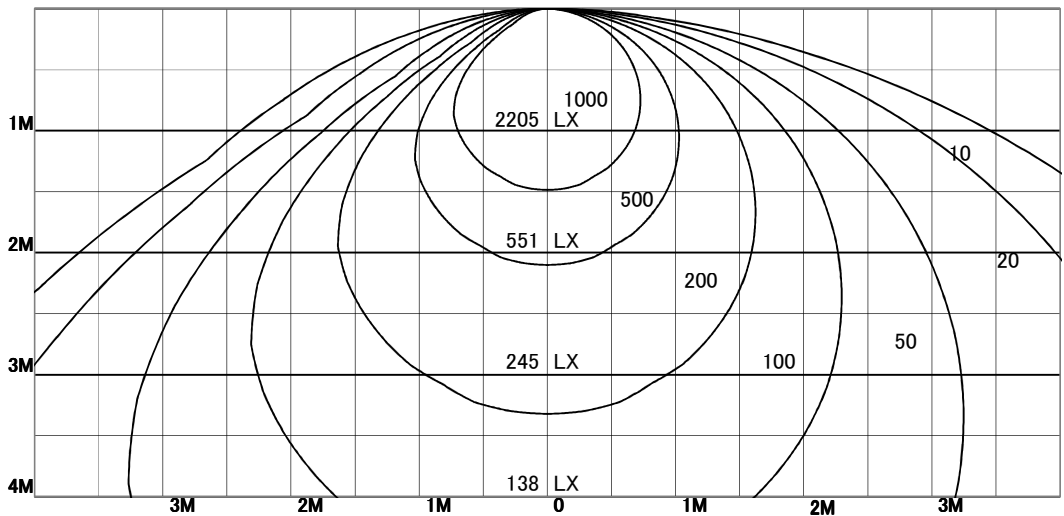

照明率表

天井	80%				70%				50%				30%				0%
	70%	50%	30%	10%	70%	50%	30%	10%	70%	50%	30%	10%	70%	50%	30%	10%	0%
壁	10%																0%
床	10%																0%
0.60	60	49	41	36	59	48	41	36	57	47	40	36	55	46	40	36	34
0.80	70	59	51	46	68	58	51	46	66	57	50	45	63	55	50	45	43
1.00	77	67	59	54	75	66	59	54	72	64	58	53	70	63	57	53	51
1.25	83	74	67	62	81	73	67	62	78	71	66	61	76	70	65	61	59
1.50	87	79	73	68	85	78	72	68	83	76	71	67	80	75	70	66	64
2.00	93	86	81	77	91	85	81	77	89	84	79	76	86	82	78	75	73
2.50	96	91	87	83	95	90	86	82	92	88	84	81	90	86	83	80	78
3.00	99	94	90	87	97	93	89	86	95	91	88	85	92	89	86	84	82
4.00	101	98	95	92	100	97	94	91	97	95	92	90	95	93	90	89	86
5.00	103	100	97	95	101	99	96	94	99	97	94	93	96	95	93	91	89
7.00	105	102	100	98	103	101	99	98	101	99	97	96	98	97	96	94	92
10.00	106	104	103	101	104	103	102	100	102	101	100	98	100	99	98	97	94