

屋内照明器具特性



品名	DD-3557-L		
光源	LED51W		
実効光束 (器具光束)	5030lm	効率	98.6lm/W

配光曲線図

実光度

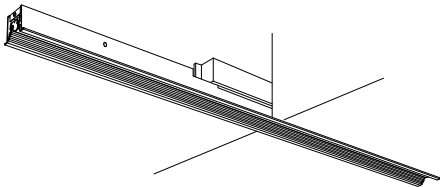
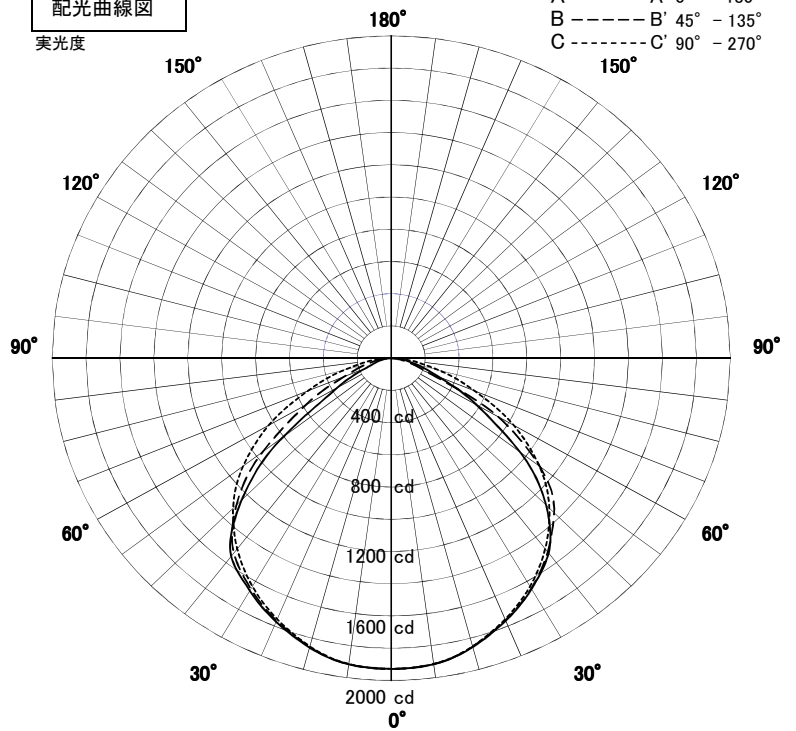

直射水平面照度

单位: Lx

A-A' Section

C-C' Section

色温度	3000K	
演色評価指数	Ra83	
保守率	良	0.63
	中	0.60
	否	0.56
1/2照度角		
A-A'	65.5	Deg
C-C'	64.5	Deg
最大取付間隔		
A-A'	1.29	H
C-C'	1.26	H

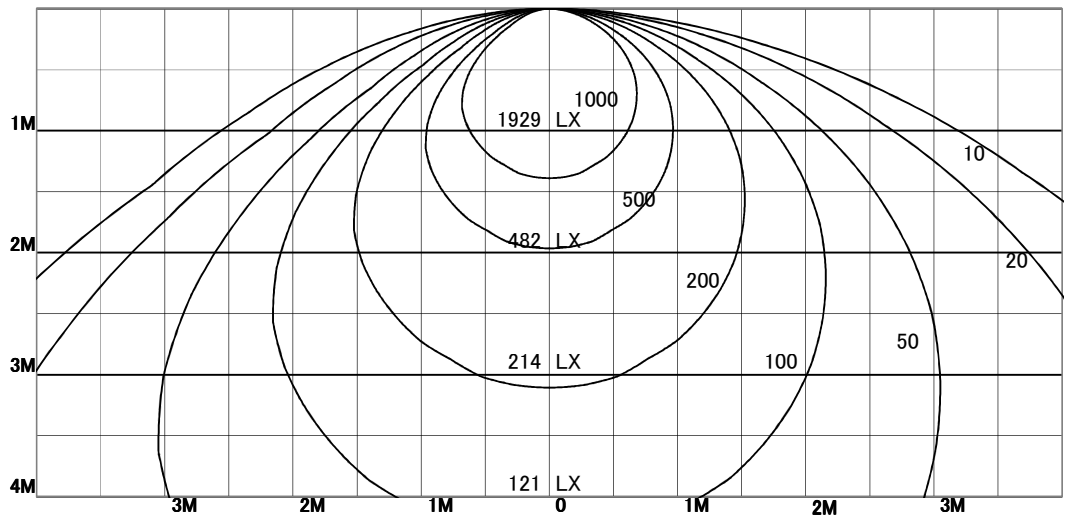

照明率表

天井	80%				70%				50%				30%				0%
	70%	50%	30%	10%	70%	50%	30%	10%	70%	50%	30%	10%	70%	50%	30%	10%	0%
壁	10%																0%
床	10%																0%
0.60	59	48	41	36	58	47	40	36	56	46	40	35	54	45	40	35	33
0.80	69	58	51	45	67	57	50	45	65	56	50	45	62	55	49	45	43
1.00	76	66	59	53	74	65	58	53	71	63	57	53	69	62	57	52	50
1.25	82	73	66	61	80	72	66	61	77	70	65	60	75	69	64	60	58
1.50	86	78	72	67	84	77	71	67	81	75	70	66	79	74	69	65	63
2.00	92	85	80	76	90	84	79	75	87	82	78	75	85	81	77	74	72
2.50	95	90	85	82	93	89	85	81	91	87	83	80	88	85	82	79	77
3.00	97	93	89	86	96	92	88	85	93	90	87	84	91	88	85	83	80
4.00	100	96	93	90	98	95	92	90	96	93	91	88	93	91	89	87	85
5.00	101	98	96	93	100	97	95	93	97	95	93	91	95	93	91	90	87
7.00	103	101	99	97	102	100	98	96	99	98	96	95	97	96	94	93	90
10.00	104	103	101	100	103	102	100	99	101	99	98	97	98	97	96	95	93