

屋内照明器具特性

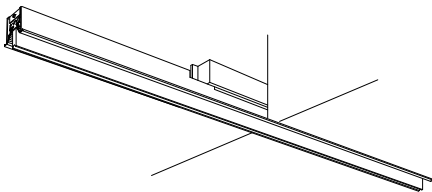

品名	DD-3561-L		
光源	LED51W		
実効光束 (器具光束)	3766lm	効率	73.8lm/W

配光曲線図
実光度

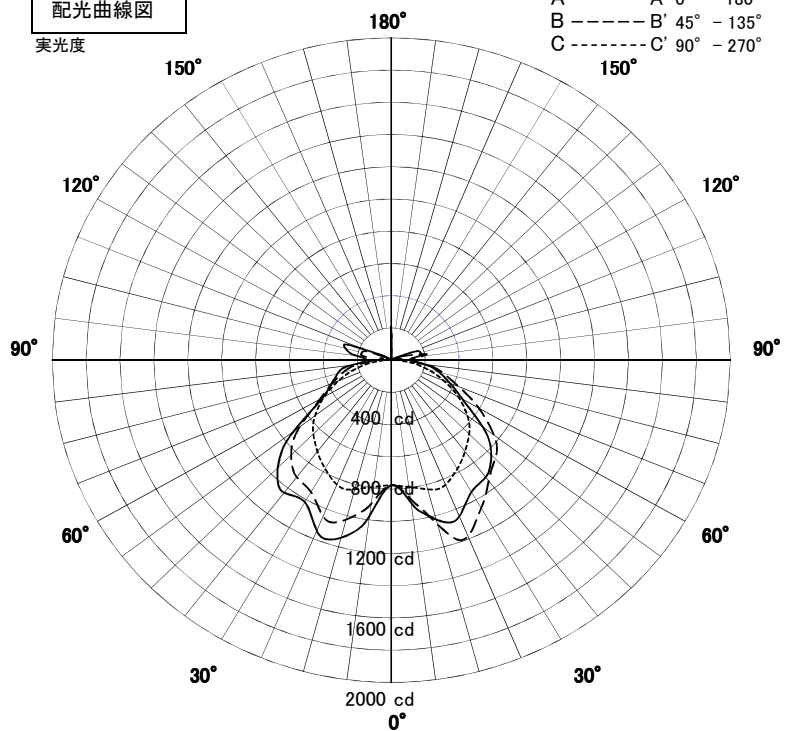

直射水平面照度

単位: Lx

A-A' Section

C-C' Section

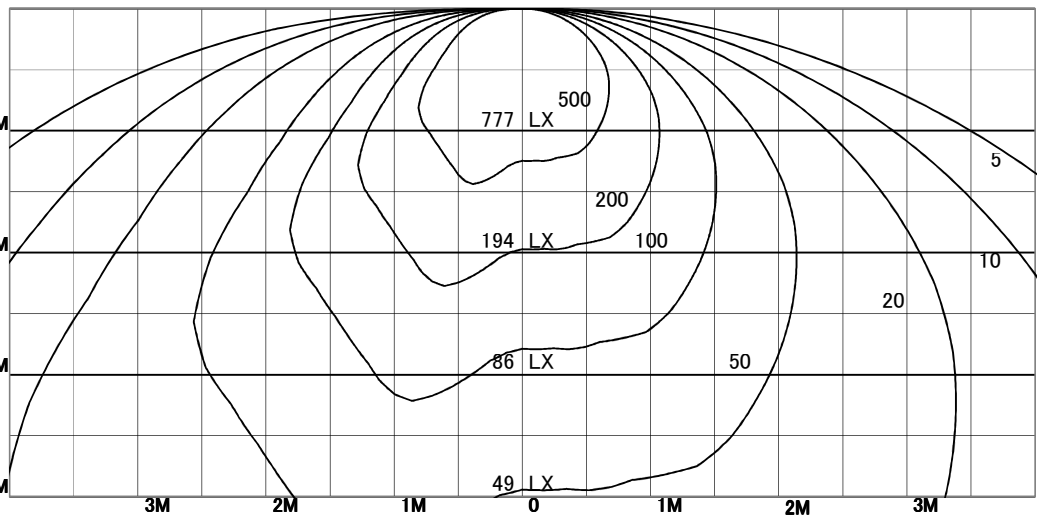

色温度	3000K	
演色評価指数	Ra83	
保守率	良	0.63
	中	0.60
	否	0.56
1/2照度角		
A-A'	84.0	Deg
C-C'	71.5	Deg
最大取付間隔		
A-A'	1.80	H
C-C'	1.44	H

照明率表

天井	80%				70%				50%				30%				0%
	70%	50%	30%	10%	70%	50%	30%	10%	70%	50%	30%	10%	70%	50%	30%	10%	0%
壁	10%																0%
床	10%																0%
0.60	49	38	31	26	48	38	31	26	46	37	30	26	44	36	30	26	24
0.80	57	47	39	34	56	46	39	34	53	45	38	34	51	43	38	33	31
1.00	63	53	46	40	62	52	46	40	59	51	45	40	57	50	44	40	38
1.25	69	59	52	47	67	59	52	47	64	57	51	46	62	55	50	46	44
1.50	73	64	58	52	71	63	57	52	68	61	56	51	65	60	55	51	49
2.00	78	71	65	60	76	70	65	60	74	68	63	59	71	66	62	59	56
2.50	81	75	70	66	80	74	70	65	77	72	68	65	74	70	67	64	61
3.00	84	78	74	70	82	77	73	69	79	75	72	68	77	73	70	67	65
4.00	86	82	78	75	85	81	78	74	82	79	76	73	80	77	75	72	70
5.00	88	85	81	78	87	84	80	78	84	81	79	76	82	79	77	75	73
7.00	90	88	85	83	89	86	84	82	86	84	82	80	84	82	81	79	76
10.00	92	90	88	86	91	89	87	85	88	87	85	84	86	85	83	82	79