

屋内照明器具特性

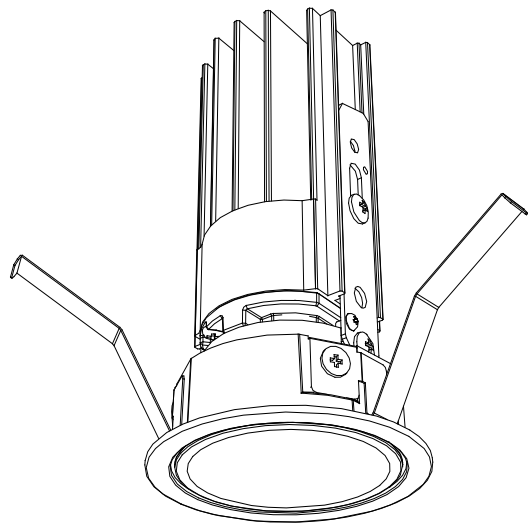

品名	DD-3577-WW		
光源	LED10.3W		
実効光束 (器具光束)	627lm	エネルギー 効率	60.8lm/W



配光曲線図
実光度

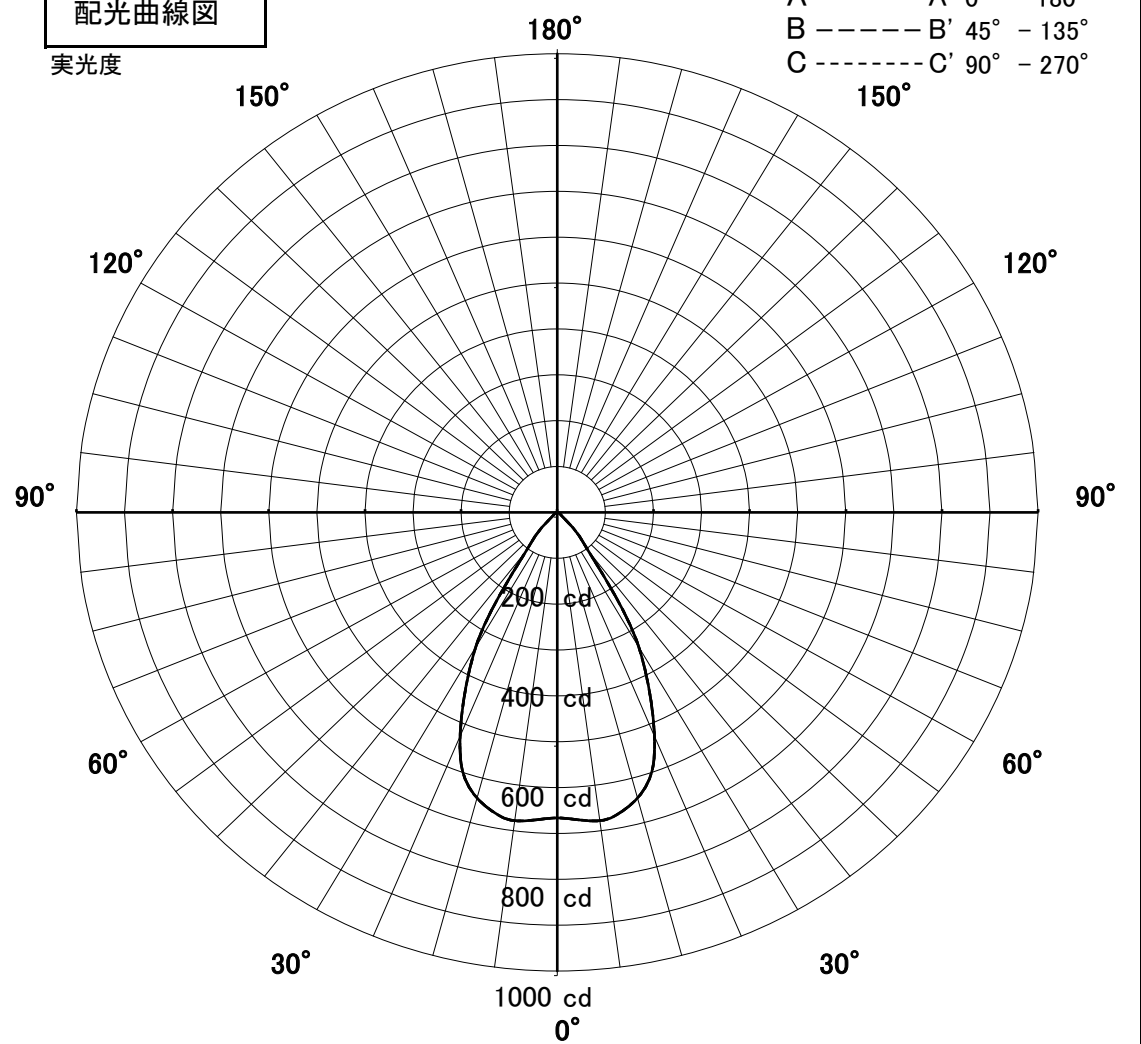

1/2照度角

直射水平面照度

単位: Lx

器具効率	59.1%	
色温度	3500K	
演色評価指数	Ra83	
保守率	良	0.67
	中	0.63
	否	0.56
1/2照度角		
A-A'	51.5	Deg
C-C'	51.5	Deg
最大取付間隔		
A-A'	0.96	H
C-C'	0.96	H

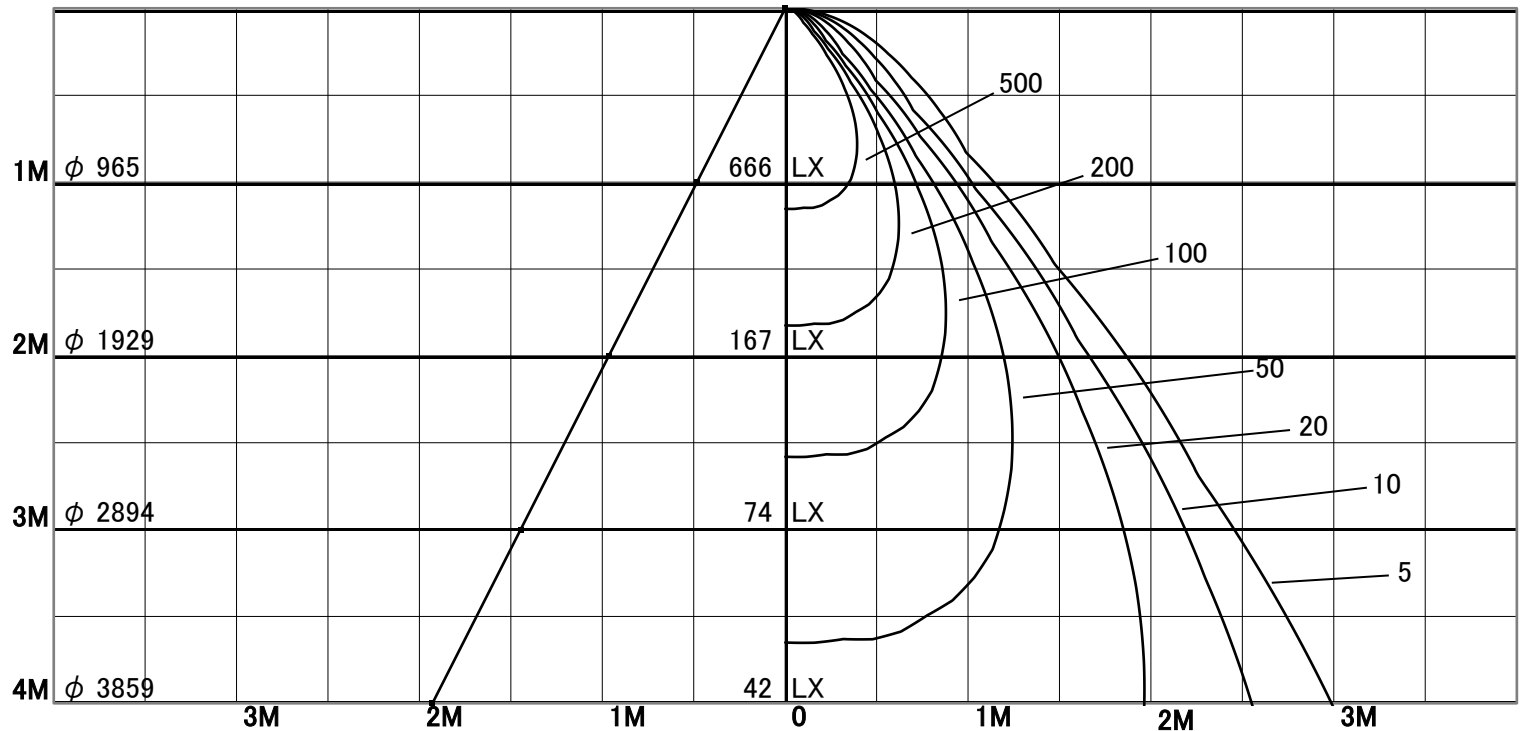

固有照明率表

	80%				70%				50%				30%				0%
	70%	50%	30%	10%	70%	50%	30%	10%	70%	50%	30%	10%	70%	50%	30%	10%	0%
天井	10%																0%
壁	10%																0%
床	10%																0%
0.60	83	77	73	70	82	76	72	70	81	76	72	70	80	75	72	69	68
0.80	89	83	78	75	88	82	78	75	86	81	78	75	84	80	77	75	74
1.00	93	88	84	81	92	87	83	81	90	86	83	80	89	85	82	80	79
1.25	96	92	88	85	95	91	88	85	93	90	87	85	92	89	86	84	83
1.50	99	95	91	89	98	94	91	89	96	93	90	88	94	91	89	87	86
2.00	102	99	97	95	101	98	96	94	99	97	95	93	97	95	94	92	91
2.50	104	102	100	98	103	101	99	98	101	99	98	97	99	98	97	96	94
3.00	106	104	102	101	105	103	102	100	103	101	100	99	101	100	99	98	96
4.00	107	106	105	104	106	105	104	103	104	103	102	101	102	101	101	100	98
5.00	108	107	106	105	107	106	105	104	105	104	103	103	103	102	102	101	99
7.00	109	108	108	107	107	107	107	106	105	105	105	104	104	103	103	103	100
10.00	109	109	109	108	108	108	108	107	106	106	106	106	104	104	104	104	101