

屋内照明器具特性

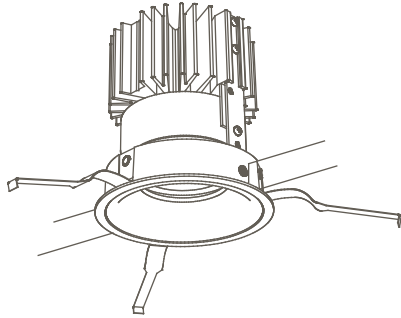

品名	DD-3631		
光源	LED 30W		
実効光束 (器具光束)	1,364 lm	効率	45.4 lm/W



配光曲線図

実光度

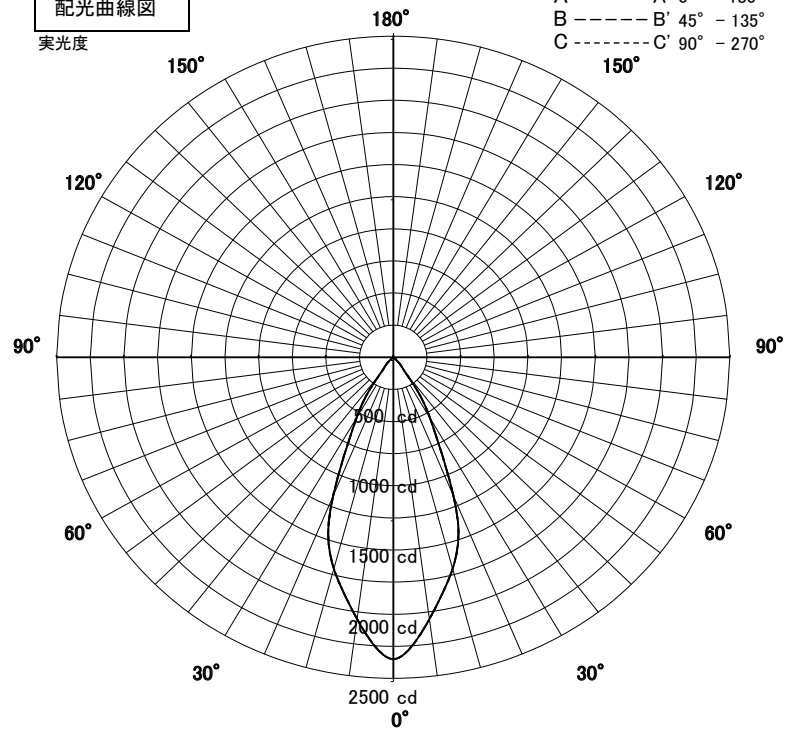

1/2照度角

直射水平面照度

単位: Lx

色温度	2700K	
演色評価指数	Ra94	
保守率	良	0.67
	中	0.63
	否	0.56

1/2照度角		
A-A'	40.0	Deg
C-C'	40.0	Deg
最大取付間隔		
A-A'	0.73	H
C-C'	0.73	H

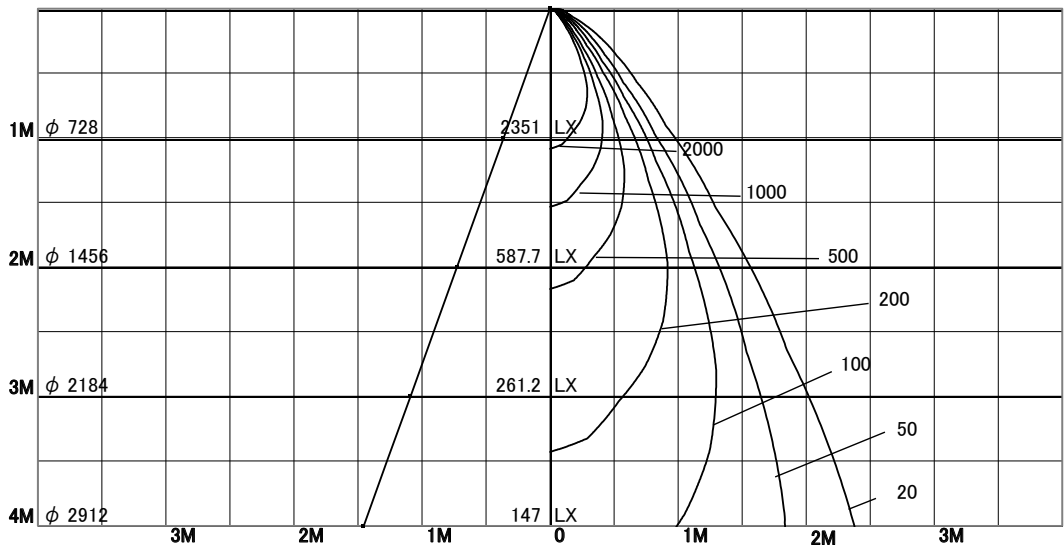

照明率表

天井	80%				70%				50%				30%				0%
	70%	50%	30%	10%	70%	50%	30%	10%	70%	50%	30%	10%	70%	50%	30%	10%	
壁	10%																0%
床	10%																0%
0.60	83	77	74	71	83	77	73	71	81	76	73	71	80	76	73	71	70
0.80	88	83	79	76	88	82	79	76	86	82	78	76	85	81	78	76	74
1.00	93	88	84	82	92	87	84	81	90	86	83	81	89	85	83	81	79
1.25	96	92	88	86	95	91	88	86	93	90	87	85	91	89	86	85	83
1.50	98	94	91	89	97	94	91	89	95	92	90	88	93	91	89	87	86
2.00	101	98	96	94	100	98	96	94	98	96	95	93	97	95	93	92	90
2.50	103	101	99	98	102	100	99	97	100	99	97	96	99	97	96	95	93
3.00	105	103	102	100	104	102	101	100	102	101	100	99	100	99	98	97	96
4.00	106	105	104	103	105	104	103	102	103	102	101	101	101	100	100	99	97
5.00	106	106	105	104	105	105	104	104	104	103	102	102	102	101	101	101	98
7.00	107	107	106	106	106	106	106	105	104	104	104	104	102	102	102	102	100
10.00	108	108	107	107	107	107	106	106	105	105	105	105	103	103	103	103	100

屋内照明器具特性



品名	DD-3631		
光源	LED 30W		
実効光束 (器具光束)	1,790 lm	効率	59.6 lm/W

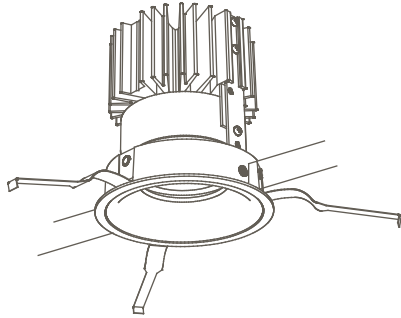

配光曲線図

実光度

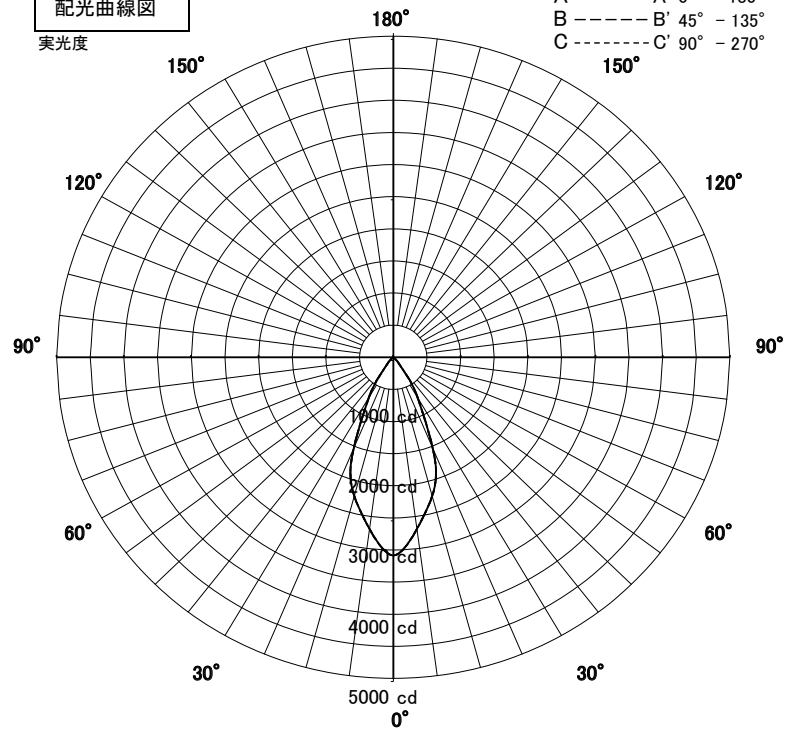

1/2照度角

直射水平面照度

単位: Lx

色温度	5000K	
演色評価指数	Ra93	
保守率	良	0.67
	中	0.63
	否	0.56

1/2照度角		
A-A'	40.0	Deg
C-C'	40.0	Deg
最大取付間隔		
A-A'	0.73	H
C-C'	0.73	H

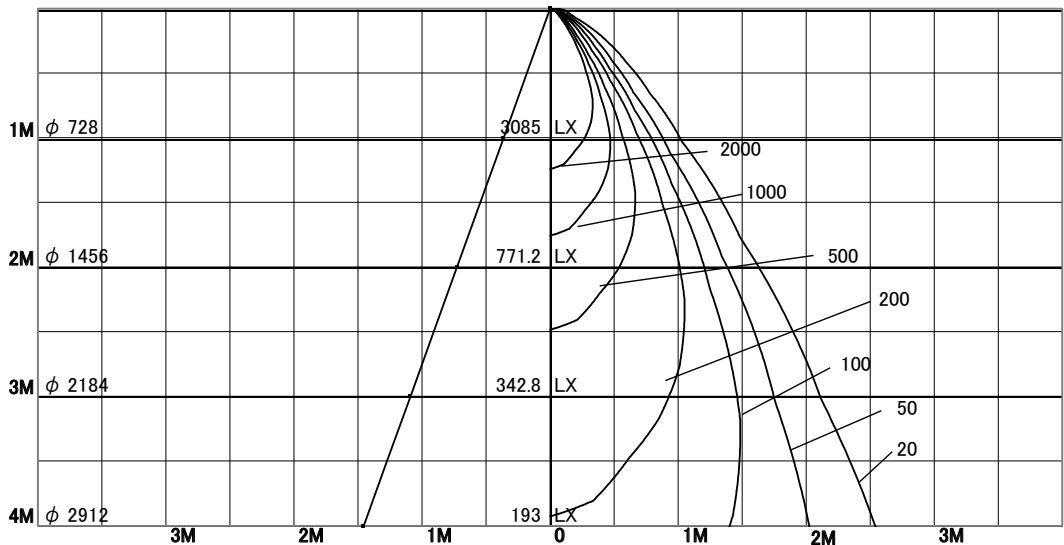

照明率表

天井	80%				70%				50%				30%				0%
	70%	50%	30%	10%	70%	50%	30%	10%	70%	50%	30%	10%	70%	50%	30%	10%	
壁	10%																0%
床	10%																0%
0.60	83	77	74	71	83	77	73	71	81	76	73	71	80	76	73	71	70
0.80	88	83	79	76	88	82	79	76	86	82	78	76	85	81	78	76	74
1.00	93	88	84	82	92	87	84	81	90	86	83	81	89	85	83	81	79
1.25	96	92	88	86	95	91	88	86	93	90	87	85	91	89	86	85	83
1.50	98	94	91	89	97	94	91	89	95	92	90	88	93	91	89	87	86
2.00	101	98	96	94	100	98	96	94	98	96	95	93	97	95	93	92	90
2.50	103	101	99	98	102	100	99	97	100	99	97	96	99	97	96	95	93
3.00	105	103	102	100	104	102	101	100	102	101	100	99	100	99	98	97	96
4.00	106	105	104	103	105	104	103	102	103	102	101	101	101	100	100	99	97
5.00	106	106	105	104	105	105	104	104	104	103	102	102	102	101	101	101	98
7.00	107	107	106	106	106	106	106	105	104	104	104	104	102	102	102	102	100
10.00	108	108	107	107	107	107	106	106	105	105	105	105	103	103	103	103	100