

屋内照明器具特性

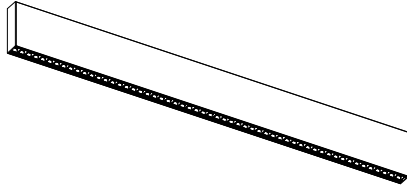

品名	LD-5349-W+OP-1001		
光源	LED_26.8W × 1		
実効光束 (器具光束)	2,940 lm	効率	109.7 lm/W



【ルーバー】OP-1001: 白色マット

配光曲線図

実光度

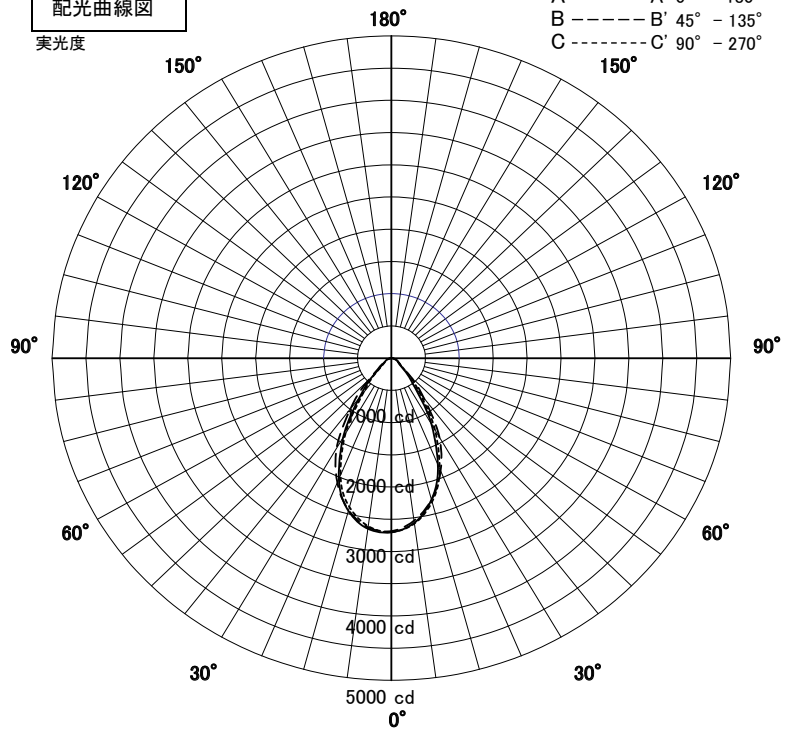

直射水平面照度

単位: Lx

A-A' Section

C-C' Section

色温度	4000K	
演色評価指数	Ra90	
保守率	良	0.69
	中	0.67
	否	0.63
1/2照度角		
A-A'	48.5	Deg
C-C'	48.5	Deg
最大取付間隔		
A-A'	0.90	H
C-C'	0.90	H

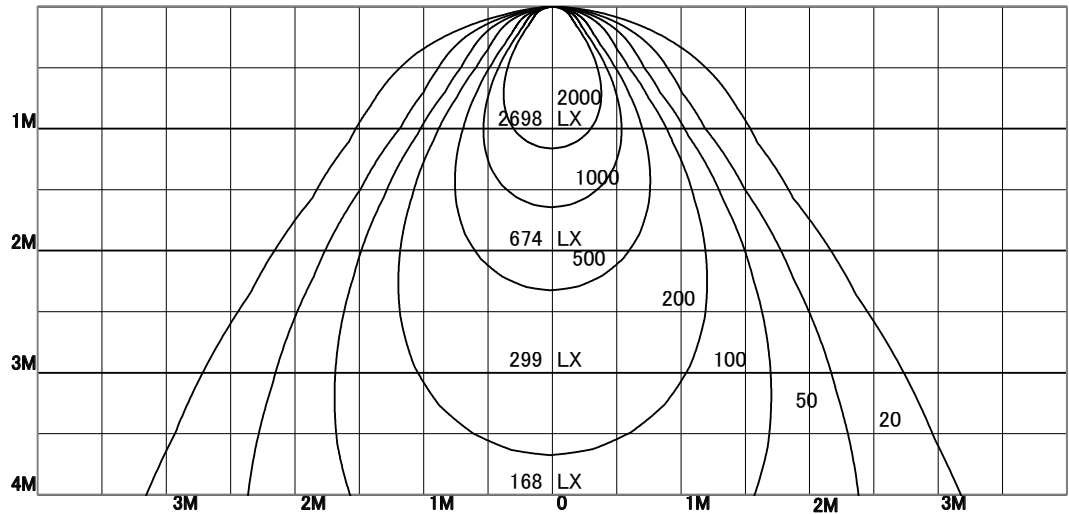

照明率表

	80%				70%				50%				30%				0%
	70%	50%	30%	10%	70%	50%	30%	10%	70%	50%	30%	10%	70%	50%	30%	10%	0%
天井																	
壁																	
床		10%				10%				10%				10%			0%
0.60	77	69	64	60	76	68	63	60	74	67	63	60	73	67	63	60	58
0.80	83	76	71	67	82	75	70	67	80	74	70	66	78	73	69	66	65
1.00	88	82	77	73	87	81	76	73	85	80	76	73	83	79	75	72	71
1.25	93	87	82	79	91	86	82	78	89	85	81	78	87	83	80	77	76
1.50	95	90	86	83	94	89	86	83	92	88	85	82	90	87	84	81	79
2.00	100	96	92	89	98	95	92	89	96	93	90	88	94	92	89	87	85
2.50	102	99	96	94	101	98	95	93	99	96	94	92	97	95	93	91	89
3.00	104	101	99	97	103	100	98	96	100	98	97	95	98	97	95	94	92
4.00	105	104	102	100	104	103	101	100	102	101	99	98	100	99	98	97	95
5.00	106	105	104	102	105	104	103	101	103	102	101	100	101	100	99	99	96
7.00	108	107	106	105	106	106	105	104	104	104	103	102	102	102	101	101	98
10.00	108	108	107	107	107	107	106	106	105	105	104	104	103	103	102	102	99

屋内照明器具特性



品名	LD-5349-W+OP-1002		
光源	LED_26.8W × 1		
実効光束 (器具光束)	2,409 lm	効率	89.8 lm/W

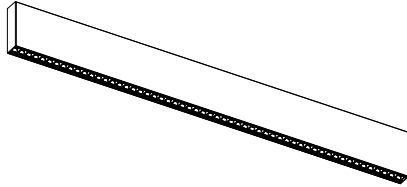

【ルーバー】OP-1002:黒色

配光曲線図

実光度

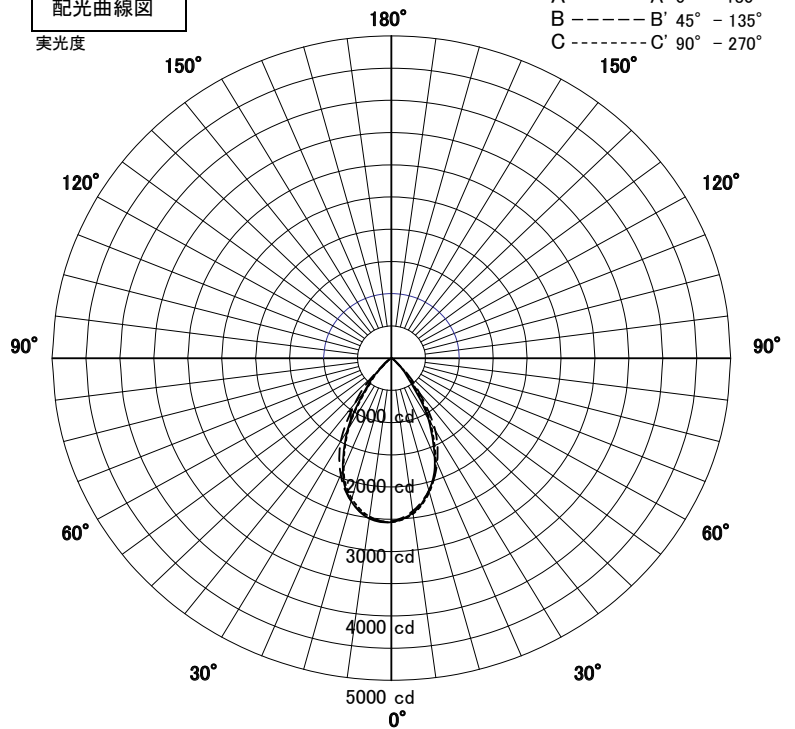

直射水平面照度

単位:Lx

A-A' Section

C-C' Section

色温度	4000K	
演色評価指数	Ra90	
保守率	良	0.69
	中	0.67
	否	0.63
1/2照度角		
A-A'	48.0	Deg
C-C'	48.0	Deg
最大取付間隔		
A-A'	0.89	H
C-C'	0.89	H

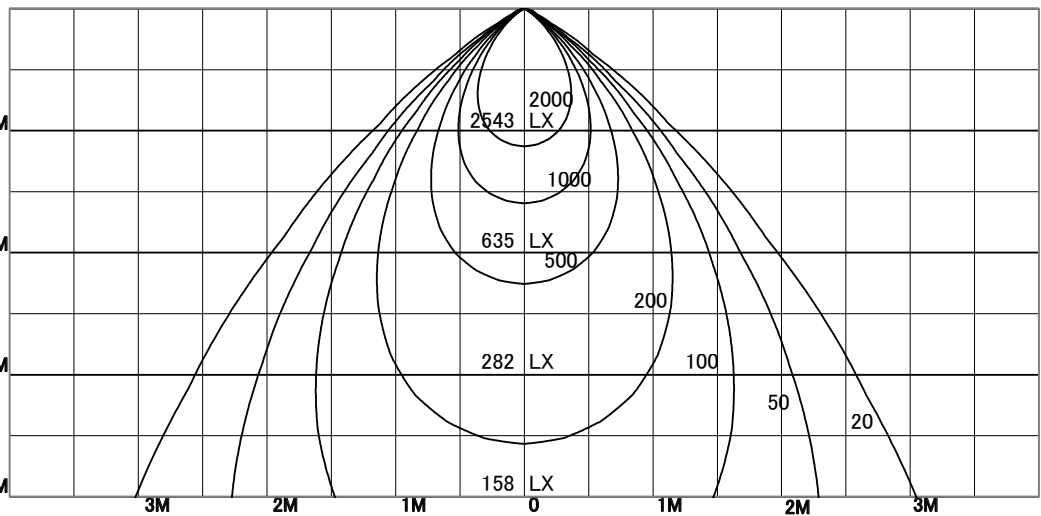

照明率表

	80%				70%				50%				30%				0%
	70%	50%	30%	10%	70%	50%	30%	10%	70%	50%	30%	10%	70%	50%	30%	10%	0%
天井																	
壁																	
床		10%				10%				10%				10%			0%
0.60	82	75	70	67	81	74	70	67	79	74	70	67	78	73	70	67	66
0.80	88	81	77	74	87	81	77	74	85	80	76	74	84	79	76	73	72
1.00	92	87	83	80	91	86	83	80	90	85	82	79	88	84	81	79	78
1.25	96	91	88	85	95	91	87	85	93	89	87	84	92	88	86	84	82
1.50	99	94	91	89	98	94	91	88	96	92	90	88	94	91	89	87	85
2.00	102	99	97	94	101	98	96	94	99	97	95	93	97	95	94	92	91
2.50	104	102	100	98	103	101	99	98	101	100	98	97	100	98	97	96	94
3.00	106	104	102	101	105	103	102	100	103	101	100	99	101	100	99	98	96
4.00	107	106	105	103	106	105	104	103	104	103	102	101	102	101	101	100	98
5.00	108	107	106	105	107	106	105	104	105	104	103	103	103	102	102	101	99
7.00	109	108	107	107	108	107	107	106	106	105	105	104	104	103	103	103	100
10.00	109	109	108	108	108	108	107	107	106	106	106	105	104	104	104	103	101

屋内照明器具特性



品名	LD-5349-W+OP-1003		
光源	LED_26.8W × 1		
実効光束 (器具光束)	3,084 lm	効率	115.0 lm/W

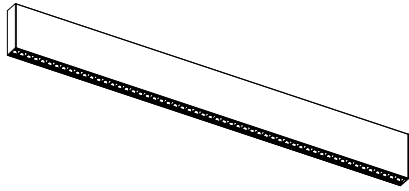

【ルーバー】OP-1003: 銀色鏡面

配光曲線図

実光度

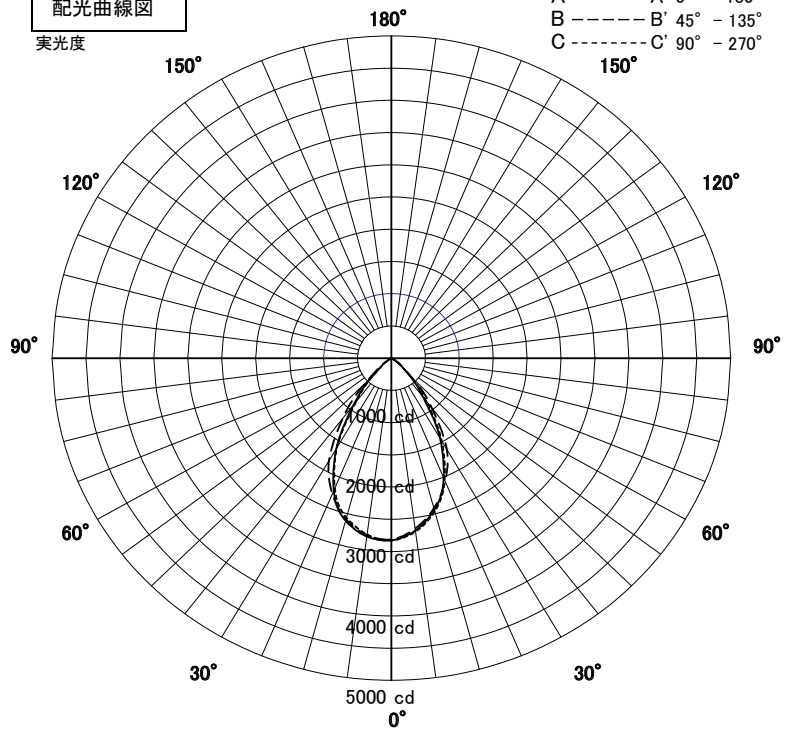

直射水平面照度

単位: Lx

A-A' Section

C-C' Section

色温度	4000K	
演色評価指数	Ra90	
保守率	良	0.69
	中	0.67
	否	0.63
1/2照度角		
A-A'	51.0	Deg
C-C'	50.5	Deg
最大取付間隔		
A-A'	0.95	H
C-C'	0.94	H

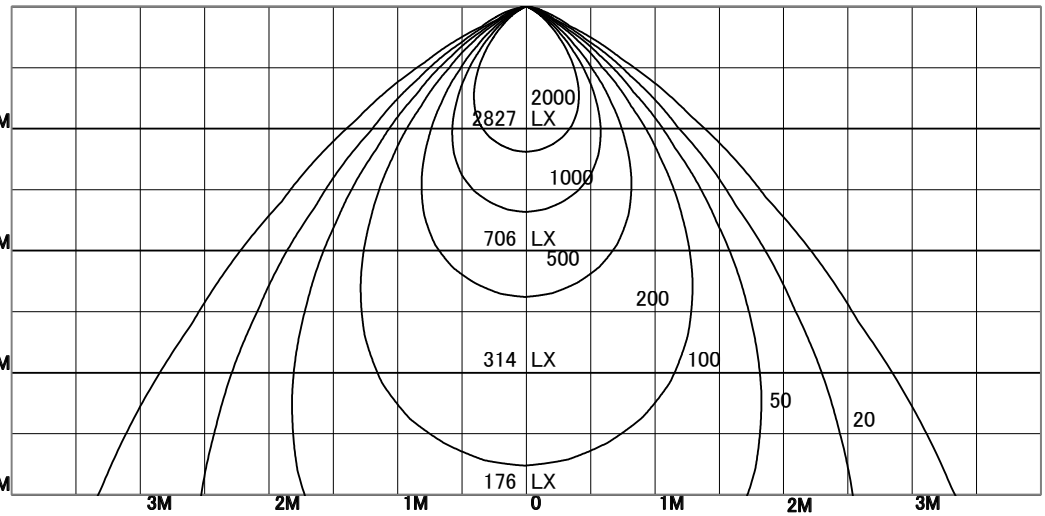

照明率表

	80%				70%				50%				30%				0%
	70%	50%	30%	10%	70%	50%	30%	10%	70%	50%	30%	10%	70%	50%	30%	10%	0%
天井																	
壁																	
床		10%				10%				10%				10%			0%
0.60	79	72	67	63	78	71	67	63	77	70	66	63	75	70	66	63	62
0.80	86	79	74	71	85	78	74	71	83	77	73	70	81	76	73	70	69
1.00	91	85	80	77	90	84	80	77	88	83	79	77	86	82	79	76	75
1.25	95	90	86	83	94	89	85	82	92	88	84	82	90	86	84	81	80
1.50	97	93	89	87	96	92	89	86	94	91	88	86	92	89	87	85	83
2.00	101	98	95	93	100	97	95	92	98	96	93	92	96	94	92	91	89
2.50	104	101	99	97	102	100	98	96	100	98	97	95	99	97	95	94	92
3.00	105	103	101	100	104	102	100	99	102	100	99	98	100	99	98	97	95
4.00	106	105	104	102	105	104	103	102	103	102	101	100	101	100	100	99	97
5.00	107	106	105	104	106	105	104	103	104	103	102	102	102	101	101	100	98
7.00	108	107	107	106	107	106	106	105	105	104	104	103	103	102	102	102	99
10.00	109	108	108	107	108	107	107	106	105	105	105	104	103	103	103	103	100