

屋内照明器具特性

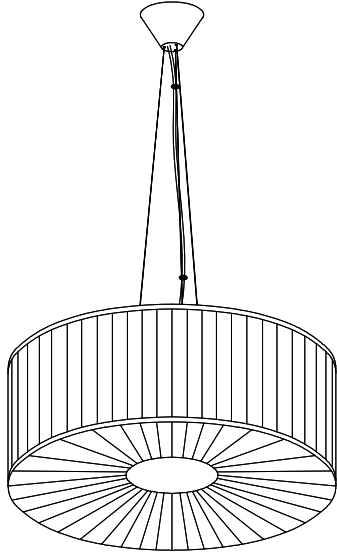

品名	PD-2624-L+KP-4093		
光源	LDA14L-G/100W × 3		
実効光束 (器具光束)	4628lm	効率	107.8lm/W



配光曲線図

実光度

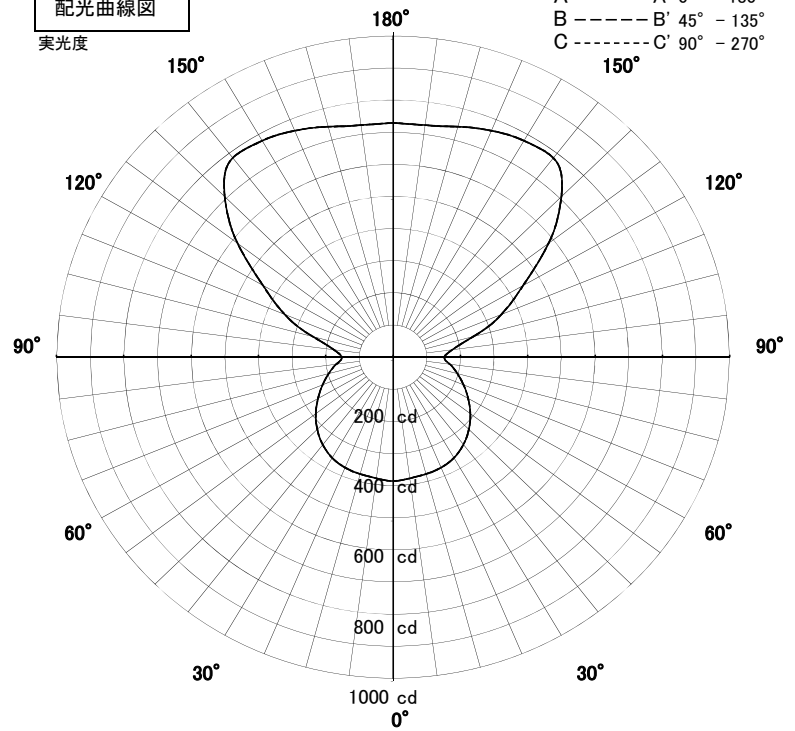

1/2照度角

直射水平面照度

単位: Lx

色温度	2700K	
演色評価指数	Ra80	
保守率	良	0.67
	中	0.63
	否	0.56

1/2照度角		
A-A'	70.0	Deg
C-C'	70.0	Deg
最大取付間隔		
A-A'	1.40	H
C-C'	1.40	H

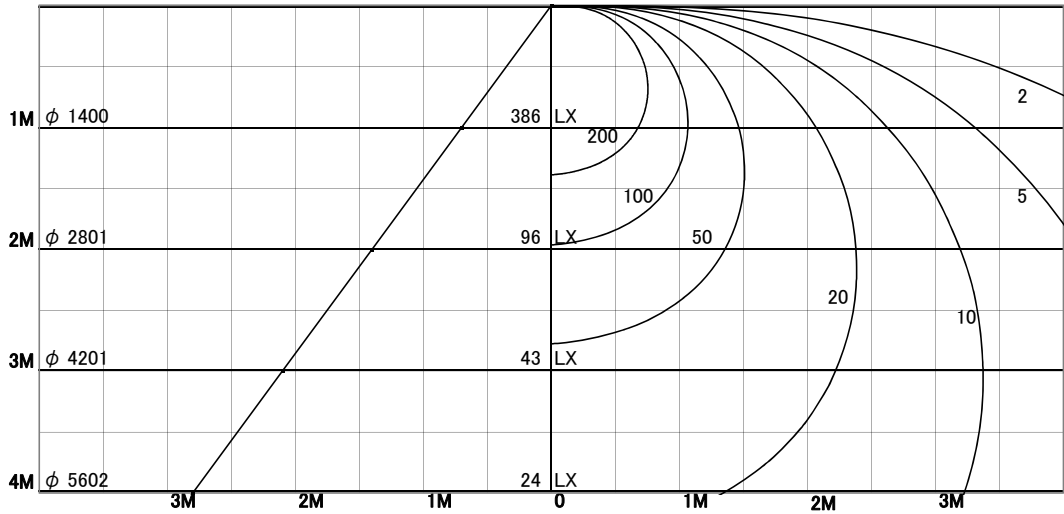

照明率表

天井	80%				70%				50%				30%				0%
	70%	50%	30%	10%	70%	50%	30%	10%	70%	50%	30%	10%	70%	50%	30%	10%	0%
壁	10%																0%
床	10%																0%
0.60	19	14	11	9	18	14	11	9	17	13	11	9	16	13	10	9	8
0.80	22	17	14	11	21	17	14	11	20	16	13	11	19	16	13	11	10
1.00	24	19	16	14	23	19	16	14	22	18	16	14	21	18	15	13	13
1.25	26	22	19	16	25	21	18	16	24	21	18	16	23	20	18	16	15
1.50	28	24	21	18	27	23	20	18	26	22	20	18	24	22	20	18	17
2.00	30	26	24	21	29	26	23	21	28	25	23	21	27	24	22	21	20
2.50	31	28	26	24	31	28	25	23	29	27	25	23	28	26	24	23	22
3.00	32	30	27	25	32	29	27	25	30	28	26	25	29	27	26	24	23
4.00	34	31	29	28	33	31	29	27	32	30	28	27	31	29	28	27	26
5.00	34	33	31	29	34	32	30	29	33	31	30	28	32	30	29	28	27
7.00	36	34	33	31	35	34	32	31	34	33	32	30	33	32	31	30	29
10.00	36	35	34	33	36	35	34	33	35	34	33	32	34	33	32	31	30