

# 屋内照明器具特性



品名	PD-2654-L		
光源	LDA5L-G-E17/S/40W		
実効光束 (器具光束)	382lm	効率	73.4lm/W



配光曲線図

実光度

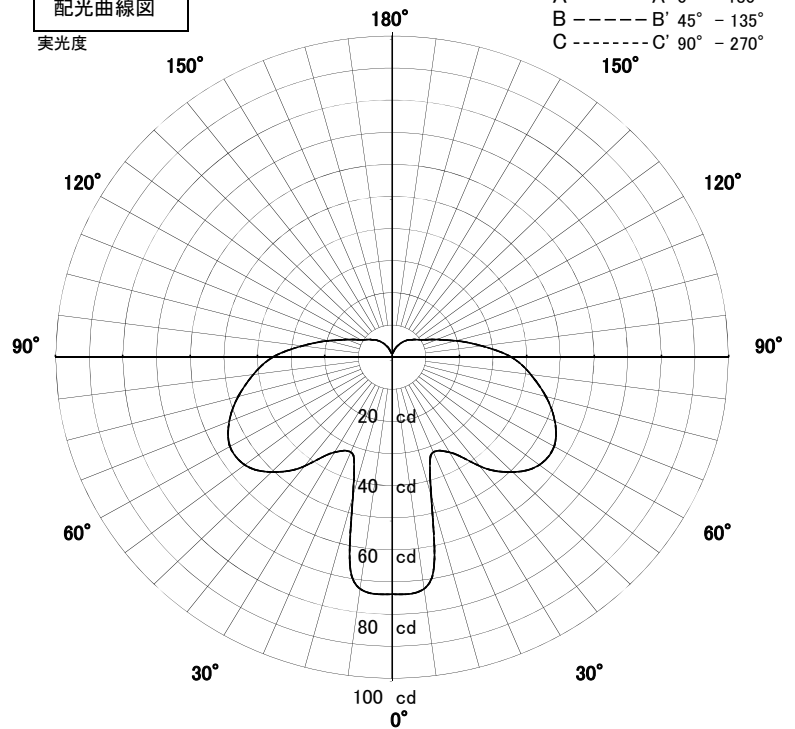

1/2照度角

直射水平面照度

単位:Lx

色温度	2700K	
演色評価指数	Ra80	
保守率	良	0.67
	中	0.63
	否	0.56

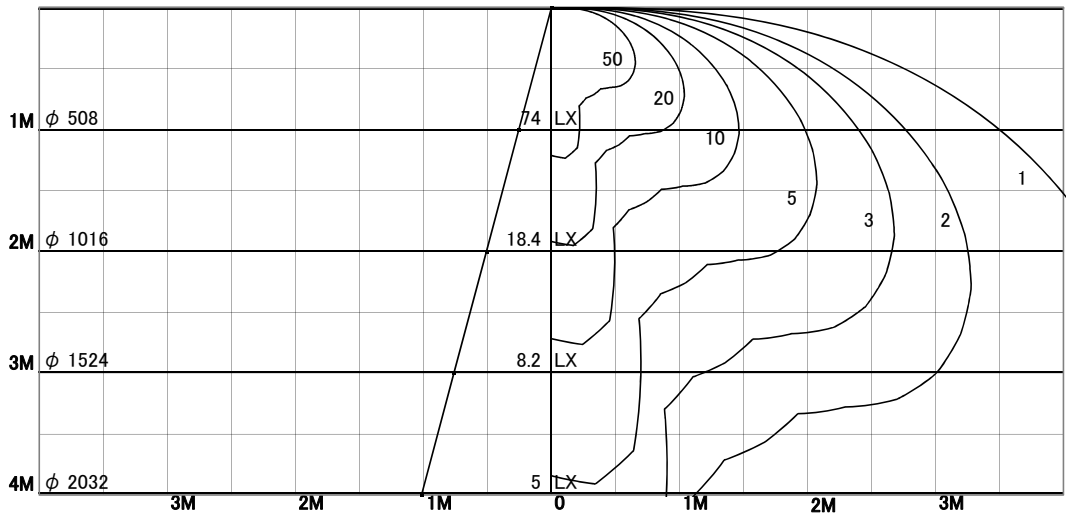

1/2照度角		
A-A'	28.5	Deg
C-C'	28.5	Deg
最大取付間隔		
A-A'	0.51	H
C-C'	0.51	H

照明率表

天井	80%				70%				50%				30%				0%
	70%	50%	30%	10%	70%	50%	30%	10%	70%	50%	30%	10%	70%	50%	30%	10%	0%
壁	10%																0%
床	10%																0%
0.60	36	25	18	13	35	24	18	13	33	23	17	13	31	23	17	12	11
0.80	43	31	24	18	41	31	23	18	39	29	23	18	36	28	22	18	16
1.00	48	37	29	23	46	36	28	23	43	34	28	22	41	33	27	22	20
1.25	53	42	34	28	51	41	34	28	48	39	33	28	45	38	32	27	25
1.50	56	46	39	32	55	45	38	32	51	44	37	32	49	42	36	31	29
2.00	61	53	46	40	60	52	45	39	57	50	44	39	54	48	43	38	36
2.50	65	57	51	45	63	56	50	45	60	54	49	44	57	52	47	43	41
3.00	67	61	54	49	66	59	54	49	63	57	52	48	60	55	51	47	45
4.00	71	65	60	55	69	64	59	55	66	62	58	54	64	60	56	53	50
5.00	73	68	63	59	71	67	62	59	69	65	61	58	66	63	59	57	54
7.00	76	72	68	64	74	70	67	64	72	68	65	63	69	66	64	61	59
10.00	78	75	72	69	76	74	71	68	74	72	69	67	72	70	68	66	63