

屋内照明器具特性

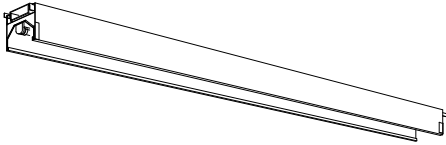

品名	YLD-9033-N		
光源	LED22.8W		
実効光束 (器具光束)	2690lm	効率	118.0lm/W



配光曲線図

実光度

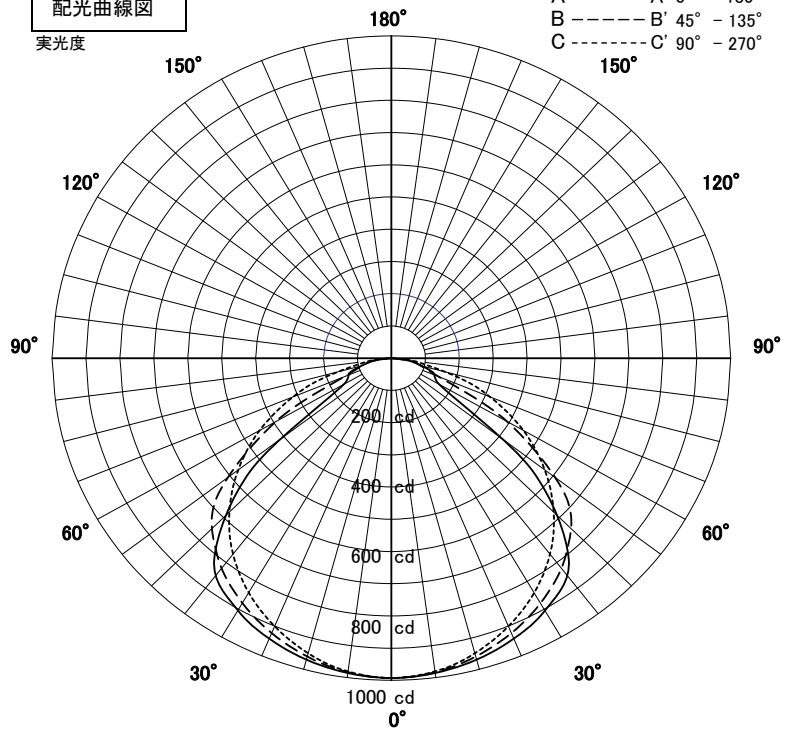

直射水平面照度

単位:Lx

A-A' Section

C-C' Section

色温度	5000K	
演色評価指数	Ra83	
保守率	良	0.67
	中	0.63
	否	0.56
1/2照度角		
A-A'	68.5	Deg
C-C'	64.5	Deg
最大取付間隔		
A-A'	1.36	H
C-C'	1.26	H

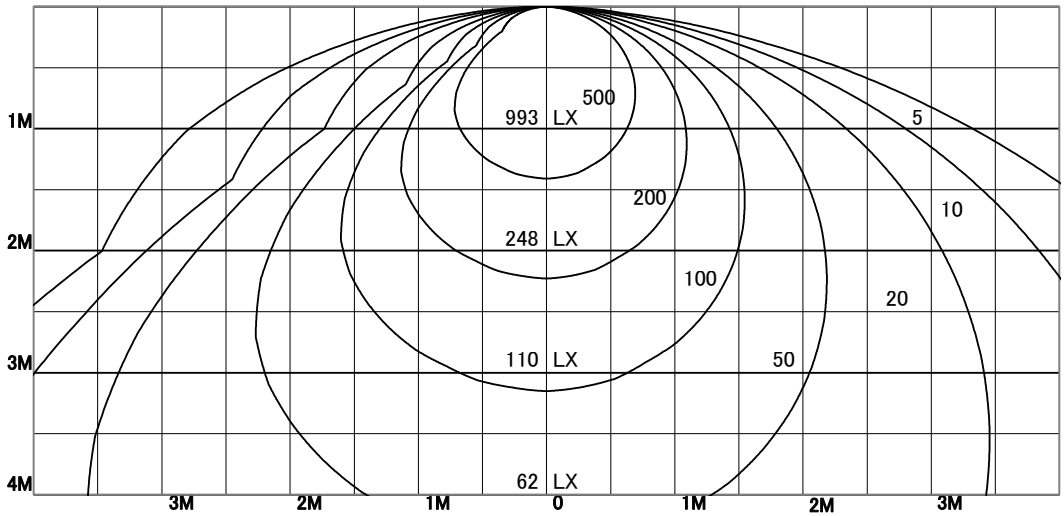

照明率表

天井	80%				70%				50%				30%				0%
	70%	50%	30%	10%	70%	50%	30%	10%	70%	50%	30%	10%	70%	50%	30%	10%	0%
壁																	0%
床																	0%
0.60	48	39	32	28	47	38	32	28	45	37	32	28	43	36	32	28	26
0.80	56	47	41	36	55	46	40	36	52	45	40	36	50	44	39	36	34
1.00	61	53	47	43	60	52	47	43	58	51	46	42	56	50	46	42	40
1.25	66	59	53	49	65	58	53	49	63	57	52	49	61	56	52	48	46
1.50	70	63	58	54	69	62	58	54	66	61	57	53	64	60	56	53	51
2.00	75	69	65	61	73	68	64	61	71	67	63	60	69	65	62	60	58
2.50	77	73	69	66	76	72	69	66	74	70	67	65	72	69	66	64	62
3.00	79	76	72	69	78	75	72	69	76	73	70	68	74	71	69	67	65
4.00	81	79	76	73	80	78	75	73	78	76	74	72	76	74	72	71	69
5.00	83	80	78	76	82	79	77	75	80	78	76	74	78	76	74	73	71
7.00	84	82	81	79	83	81	80	78	81	80	78	77	79	78	77	76	74
10.00	85	84	83	81	84	83	82	81	82	81	80	79	80	79	79	78	75