

屋外照明器具特性



品名	AD-2566-L(壁付)		
光源	LED4.7W		
実効光束 (器具光束)	287lm	効率	61.0lm/W

壁付け

配光曲線図
(実光度)

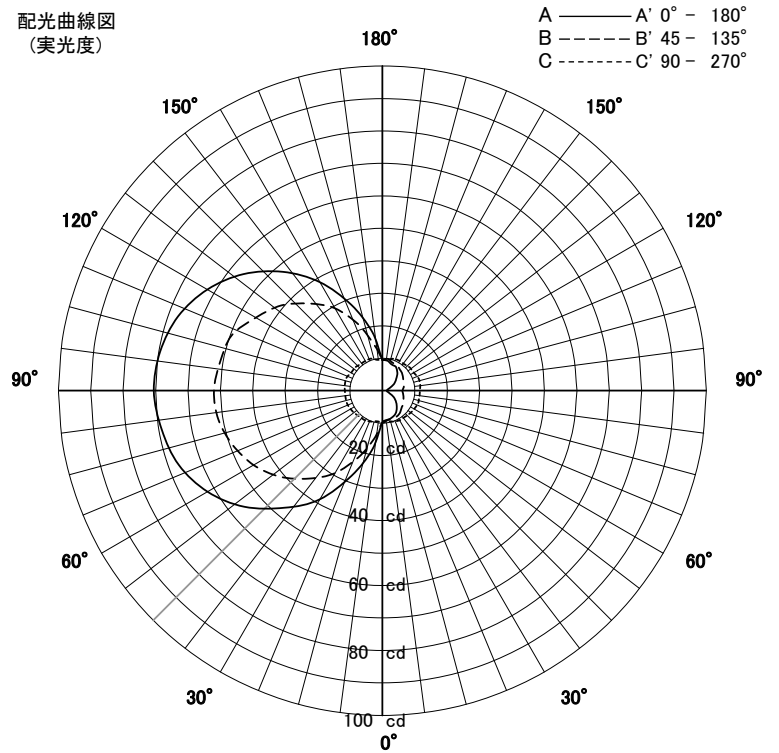

色温度	2700K	
演色評価指数	Ra83	
保守率	良	0.8
	中	0.6
	否	0.54

水平面照度分布	
単位: Lx	
地上高	2.00 M
保守率	1.00

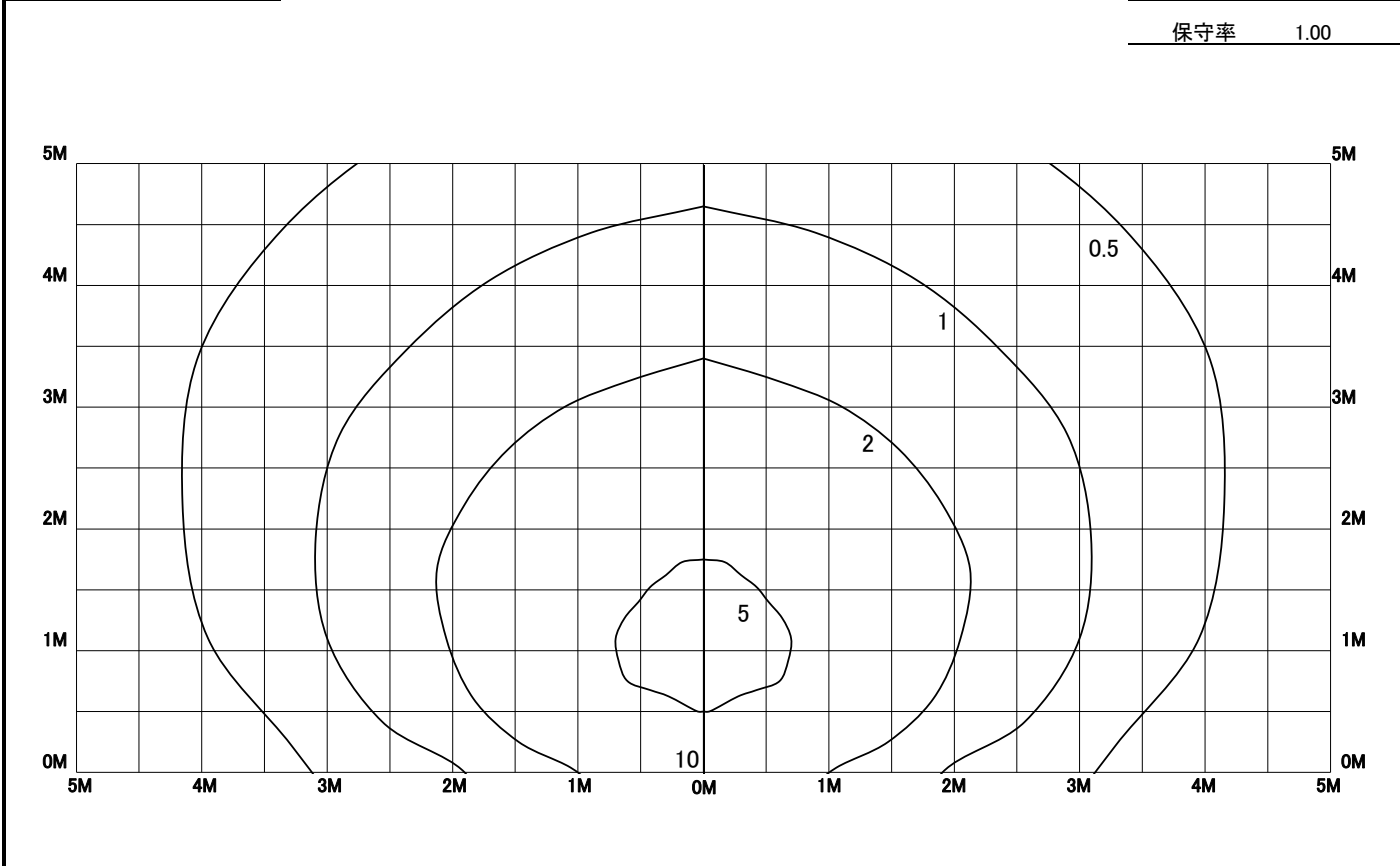

屋外照明器具特性



品名	AD-2566-L(直付)		
光源	LED4.7W		
実効光束 (器具光束)	287lm	効率	61.0lm/W

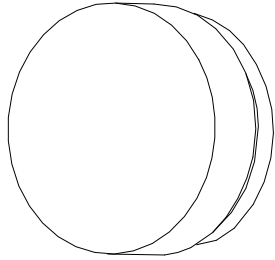

天井直付け

配光曲線図

実光度

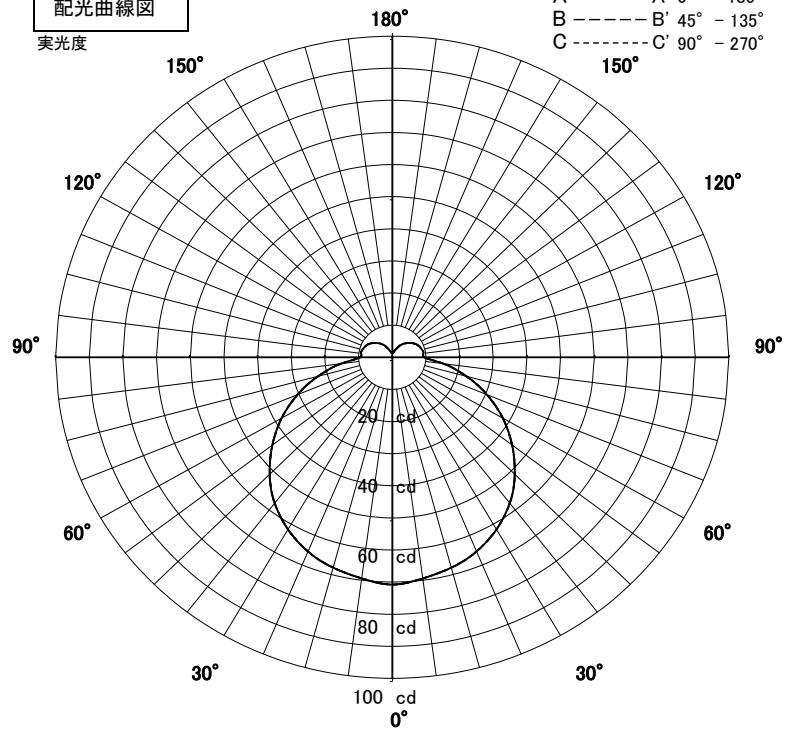

1/2照度角

直射水平面照度

単位:Lx

色温度	2700K	
演色評価指数	Ra83	
保守率	良	0.8
	中	0.6
	否	0.54

1/2照度角		
A-A'	66.0	Deg
C-C'	66.0	Deg
最大取付間隔		
A-A'	1.30	H
C-C'	1.30	H

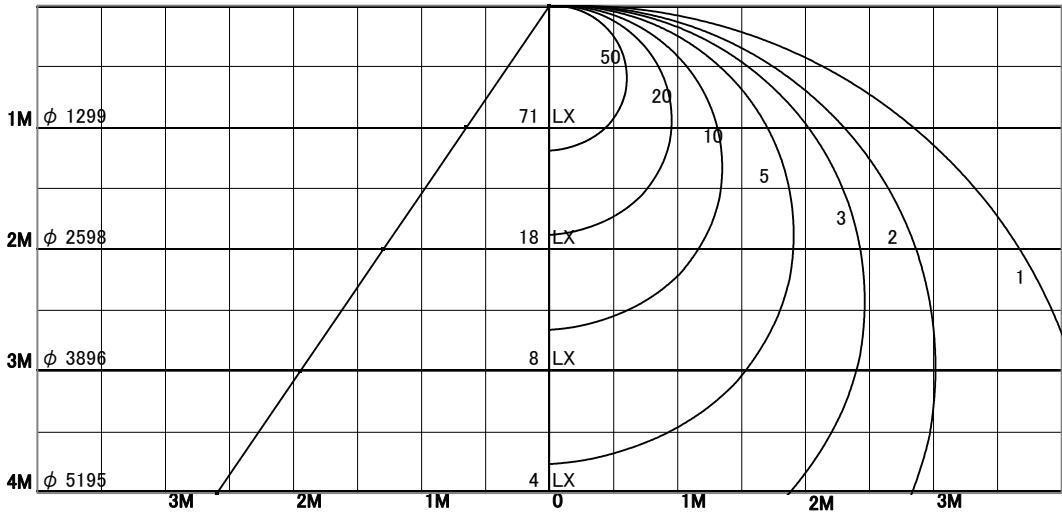

照明率表

天井	80%				70%				50%				30%				0%
	70%	50%	30%	10%	70%	50%	30%	10%	70%	50%	30%	10%	70%	50%	30%	10%	0%
壁	10%																
床	10%																
0.60	46	35	28	24	45	35	28	24	43	34	28	23	41	33	27	23	22
0.80	53	43	36	31	52	42	35	30	50	41	35	30	47	40	34	30	28
1.00	59	49	42	37	58	48	42	36	55	47	41	36	52	46	40	36	34
1.25	64	55	48	43	63	54	48	43	60	52	47	42	57	51	46	42	40
1.50	68	59	53	48	66	58	52	47	63	57	51	47	61	55	50	46	44
2.00	73	66	60	55	71	65	60	55	69	63	58	54	66	61	57	54	51
2.50	76	70	65	61	75	69	64	60	72	67	63	59	69	65	62	59	56
3.00	79	73	69	65	77	72	68	64	74	70	67	63	72	68	65	62	60
4.00	81	77	73	70	80	76	72	69	77	74	71	68	75	72	70	67	65
5.00	83	79	76	73	82	78	75	73	79	76	74	71	77	75	72	70	68
7.00	85	82	80	77	84	81	79	77	82	79	77	75	79	77	76	74	72
10.00	87	85	83	81	86	84	82	80	83	82	80	79	81	80	78	77	75