

屋内照明器具特性

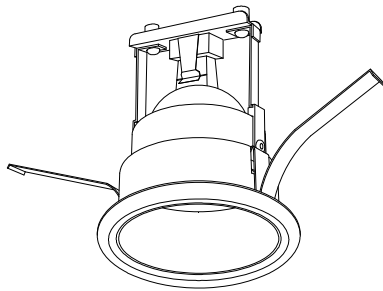

品名	DD-3100		
光源	MASTERLED_MR16_7W_3000K_24D		
実効光束 (器具光束)	380lm	効率	52.1lm/W



配光曲線図

実光度

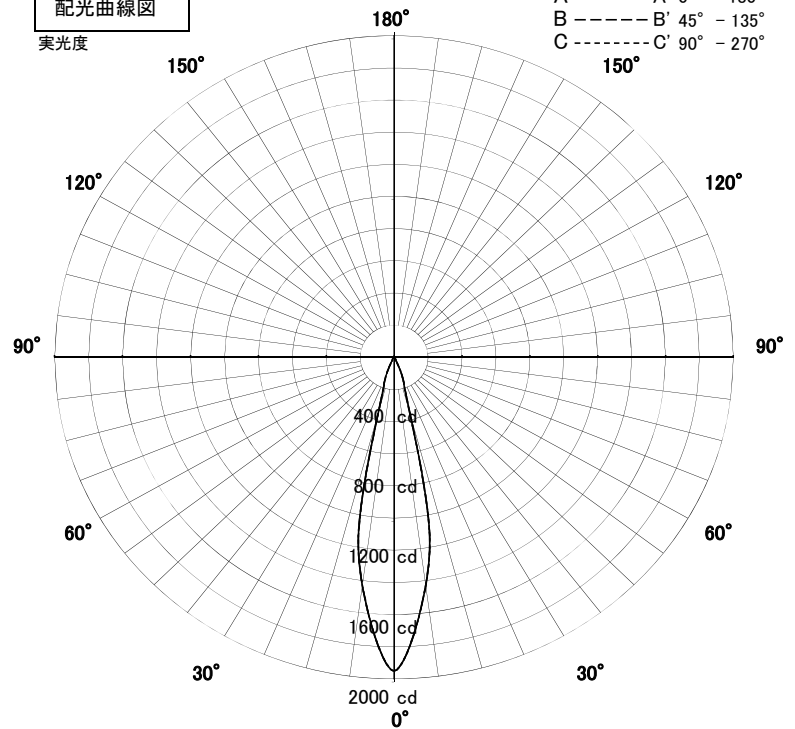

1/2照度角

直射水平面照度

単位:Lx

色温度	3000K	
演色評価指数	Ra80	
保守率	良	0.8
	中	0.6
	否	0.54

1/2照度角		
A-A'	23.5	Deg
C-C'	23.5	Deg
最大取付間隔		
A-A'	0.42	H
C-C'	0.42	H

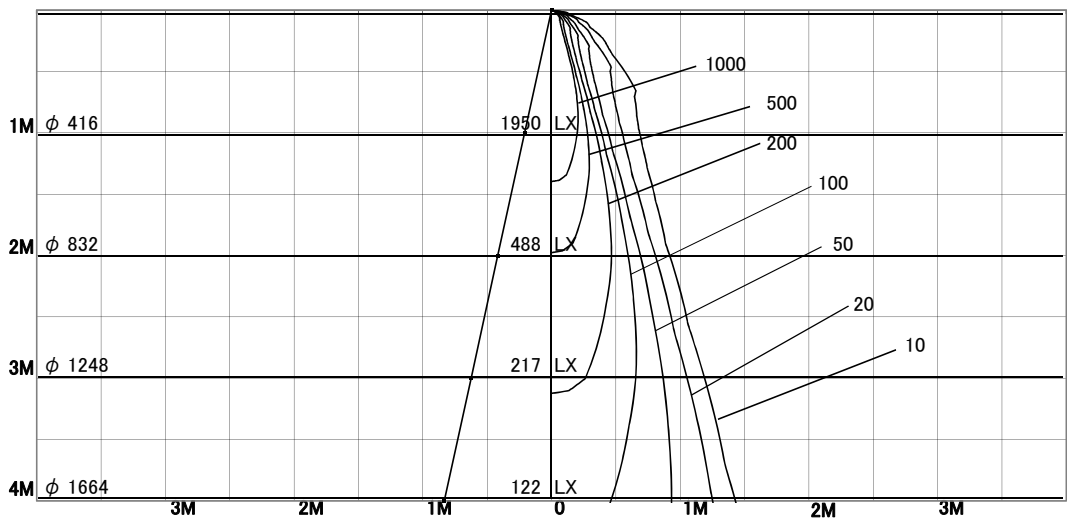

照明率表

天井	80%				70%				50%				30%				0%
	70%	50%	30%	10%	70%	50%	30%	10%	70%	50%	30%	10%	70%	50%	30%	10%	0%
壁	10%																0%
床	10%																0%
0.60	74	69	65	63	73	68	65	63	72	68	65	63	71	67	65	63	62
0.80	79	73	70	67	78	73	70	67	76	72	69	67	75	72	69	67	66
1.00	82	78	75	72	81	77	74	72	80	76	74	72	79	75	73	71	70
1.25	85	81	78	76	84	81	78	76	83	79	77	75	81	79	76	75	73
1.50	87	83	81	79	86	83	80	78	84	82	80	78	83	81	79	77	76
2.00	90	87	85	83	89	87	85	83	87	85	84	82	86	84	83	82	80
2.50	92	90	88	87	91	89	88	86	89	88	86	85	88	86	85	84	83
3.00	93	91	90	89	92	91	90	89	90	89	88	87	89	88	87	86	85
4.00	94	93	92	91	93	92	91	91	91	91	90	89	90	89	89	88	86
5.00	95	94	93	93	94	93	93	92	92	92	91	91	90	90	90	89	87
7.00	95	95	95	94	95	94	94	94	93	93	92	92	91	91	91	91	89
10.00	96	96	96	96	95	95	95	95	93	93	93	93	92	92	92	92	89