

屋内照明器具特性

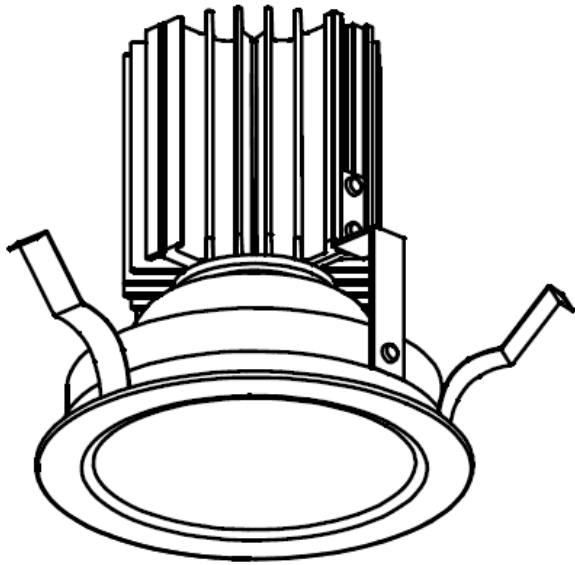

品名	DD-3207-W		
光源	LED30W		
実効光束 (器具光束)	2841lm	エネルギー 効率	94.7lm/W



配光曲線図
実光度

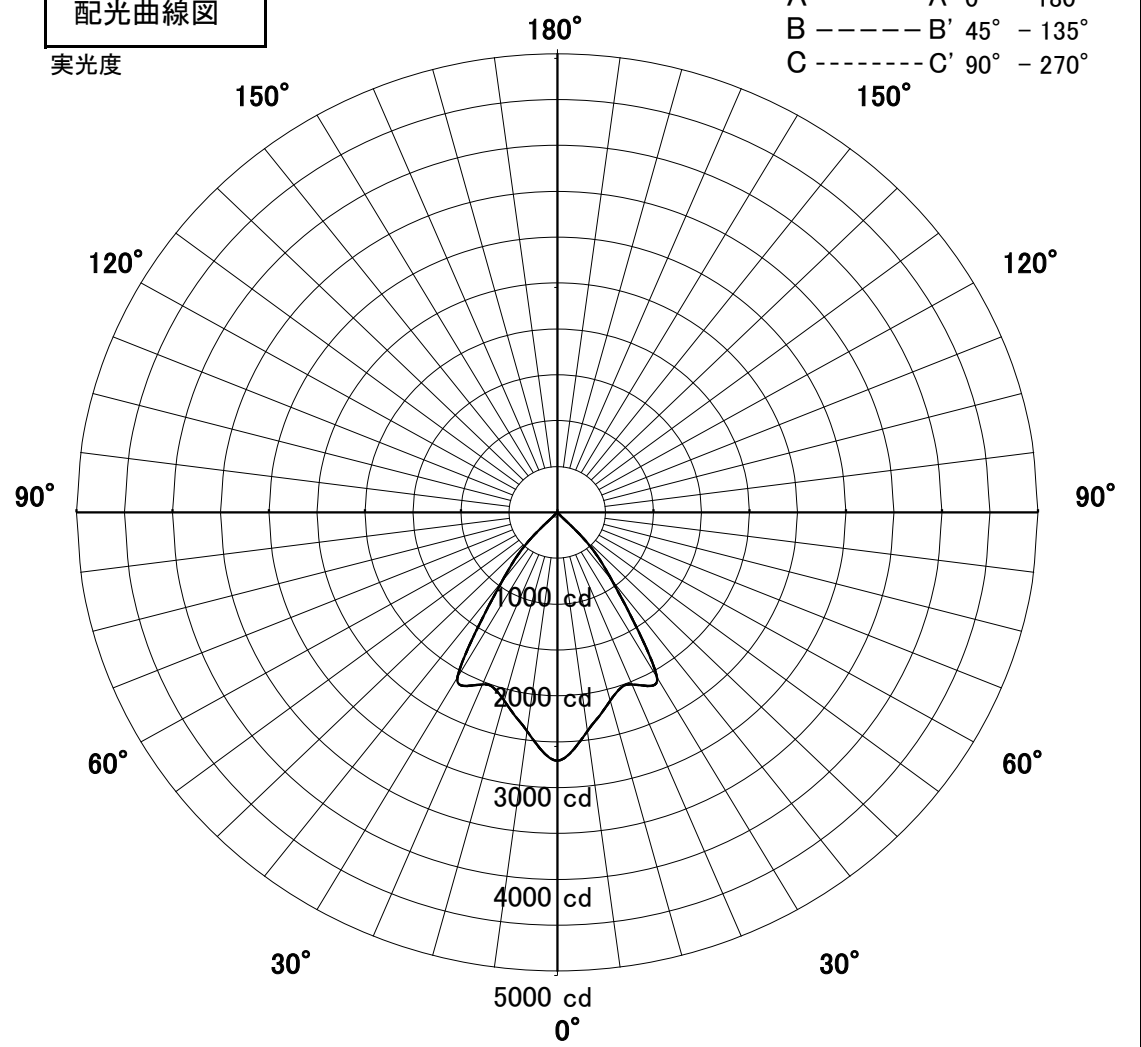

1/2照度角

直射水平面照度

単位: Lx

器具効率	91.9%	
色温度	4000K	
演色評価指数	Ra83	
保守率	良	0.67
	中	0.63
	否	0.56
1/2照度角		
A-A'	59.5	Deg
C-C'	59.5	Deg
最大取付間隔		
A-A'	1.14	H
C-C'	1.14	H

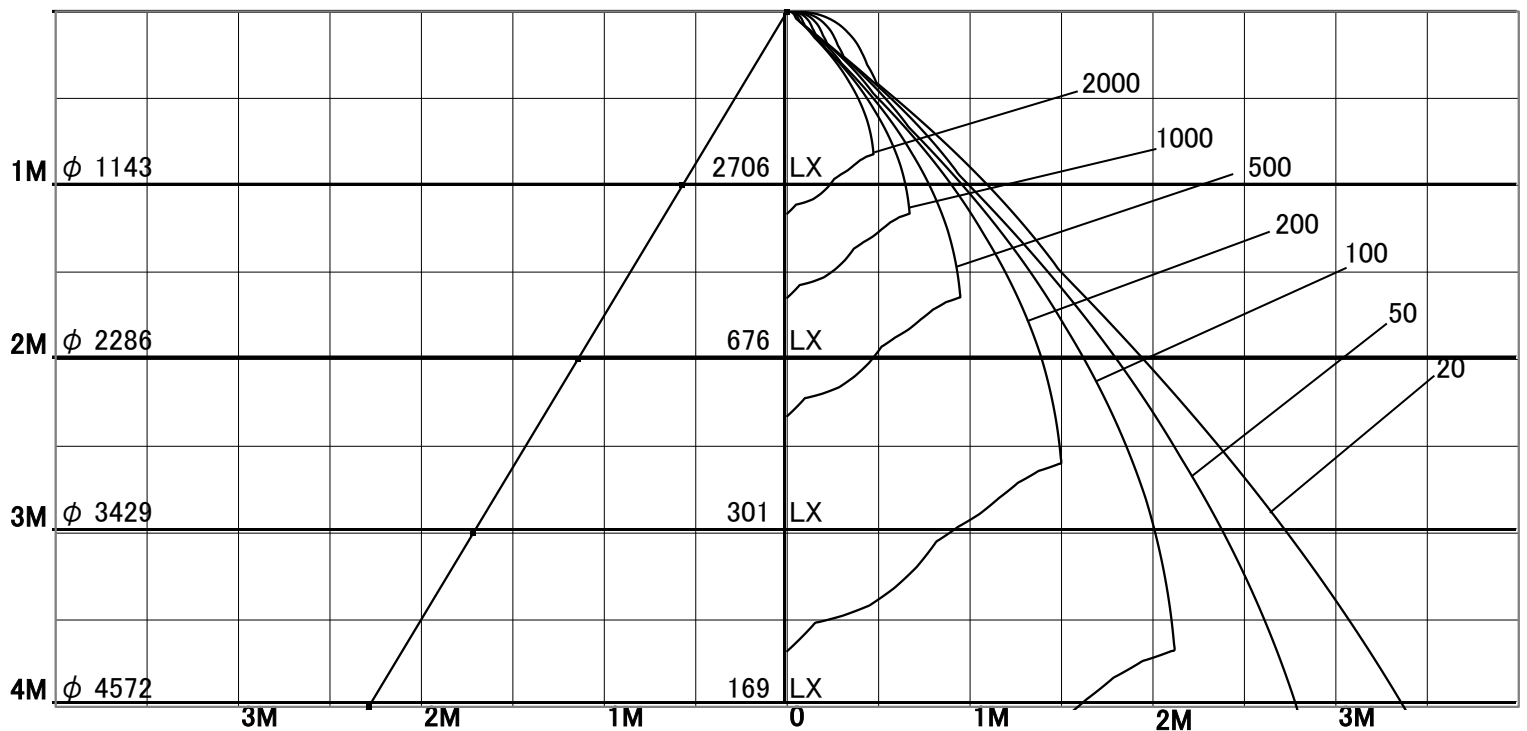

固有照明率表

	80%				70%				50%				30%				0%
	70%	50%	30%	10%	70%	50%	30%	10%	70%	50%	30%	10%	70%	50%	30%	10%	0%
天井	10%																0%
壁	10%																0%
床	10%																0%
0.60	86	79	74	71	85	78	74	71	83	78	74	71	82	77	73	71	70
0.80	91	85	81	78	91	85	80	77	89	84	80	77	87	83	79	77	76
1.00	96	91	87	84	95	90	86	83	93	89	86	83	92	88	85	83	81
1.25	100	95	91	88	99	94	91	88	97	93	90	88	95	92	89	87	86
1.50	102	98	95	92	101	97	94	92	99	96	93	91	97	95	92	90	89
2.00	106	103	100	98	105	102	100	98	103	101	98	97	101	99	97	96	94
2.50	108	106	104	102	107	105	103	101	105	103	102	100	103	102	100	99	97
3.00	110	108	106	105	109	107	105	104	107	105	104	103	105	104	103	102	100
4.00	111	110	108	107	110	109	108	107	108	107	106	105	106	105	104	104	102
5.00	112	111	110	109	111	110	109	108	109	108	107	107	107	106	105	105	103
7.00	113	112	111	111	112	111	111	110	109	109	109	108	107	107	107	107	104
10.00	113	113	113	112	112	112	112	111	110	110	110	109	108	108	108	107	105