

屋内照明器具特性

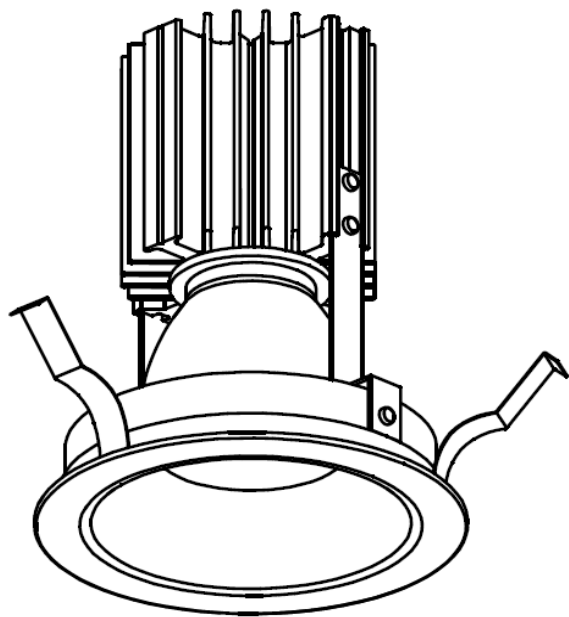

品名	DD-3209-L		
光源	LED30W		
実効光束 (器具光束)	1788lm	エネルギー 効率	59.6lm/W



配光曲線図
実光度

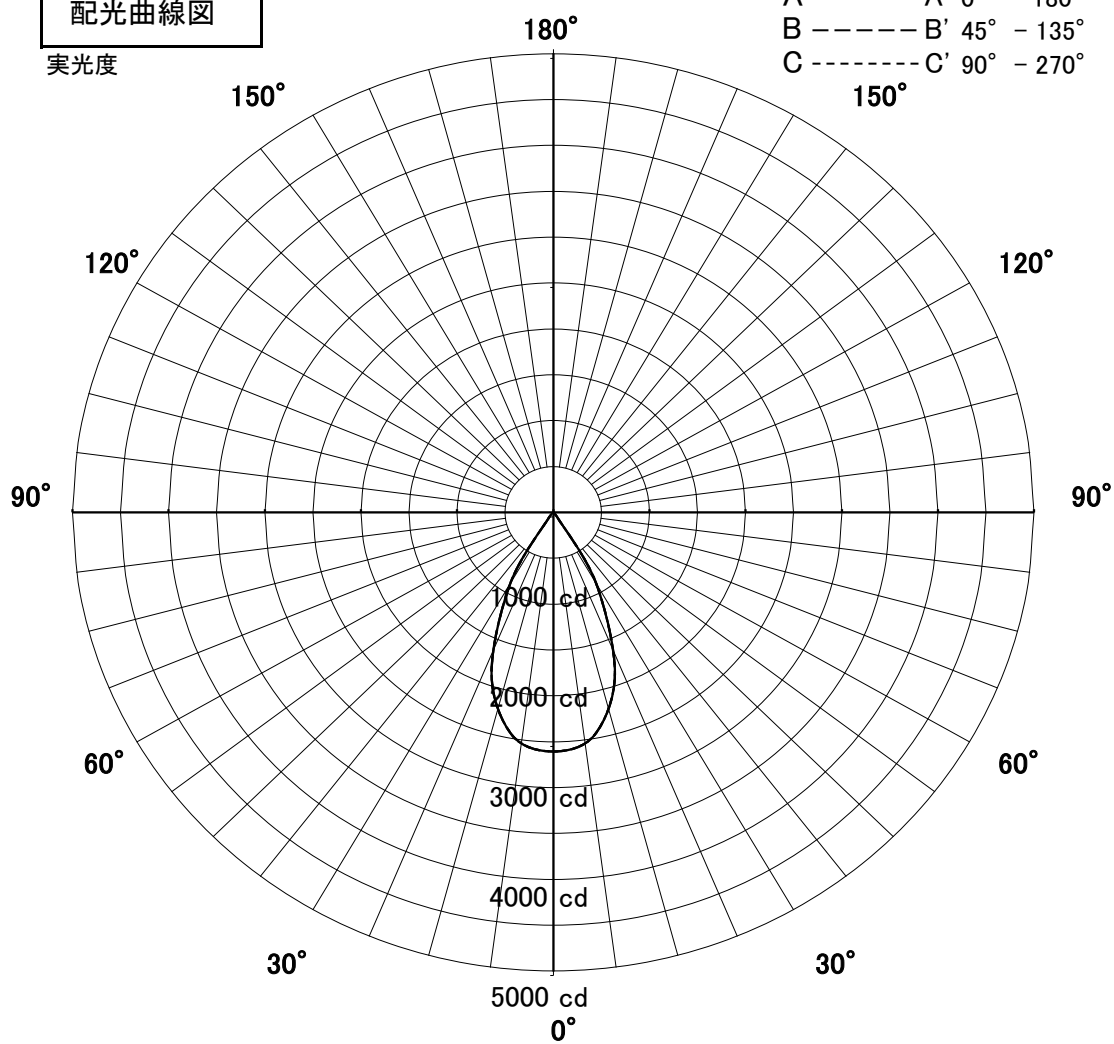

1/2照度角

直射水平面照度

単位: Lx

器具効率	59.7%	
色温度	3000K	
演色評価指数	Ra83	
保守率	良	0.67
	中	0.63
	否	0.56
1/2照度角		
A-A'	47.0	Deg
C-C'	47.0	Deg
最大取付間隔		
A-A'	0.87	H
C-C'	0.87	H

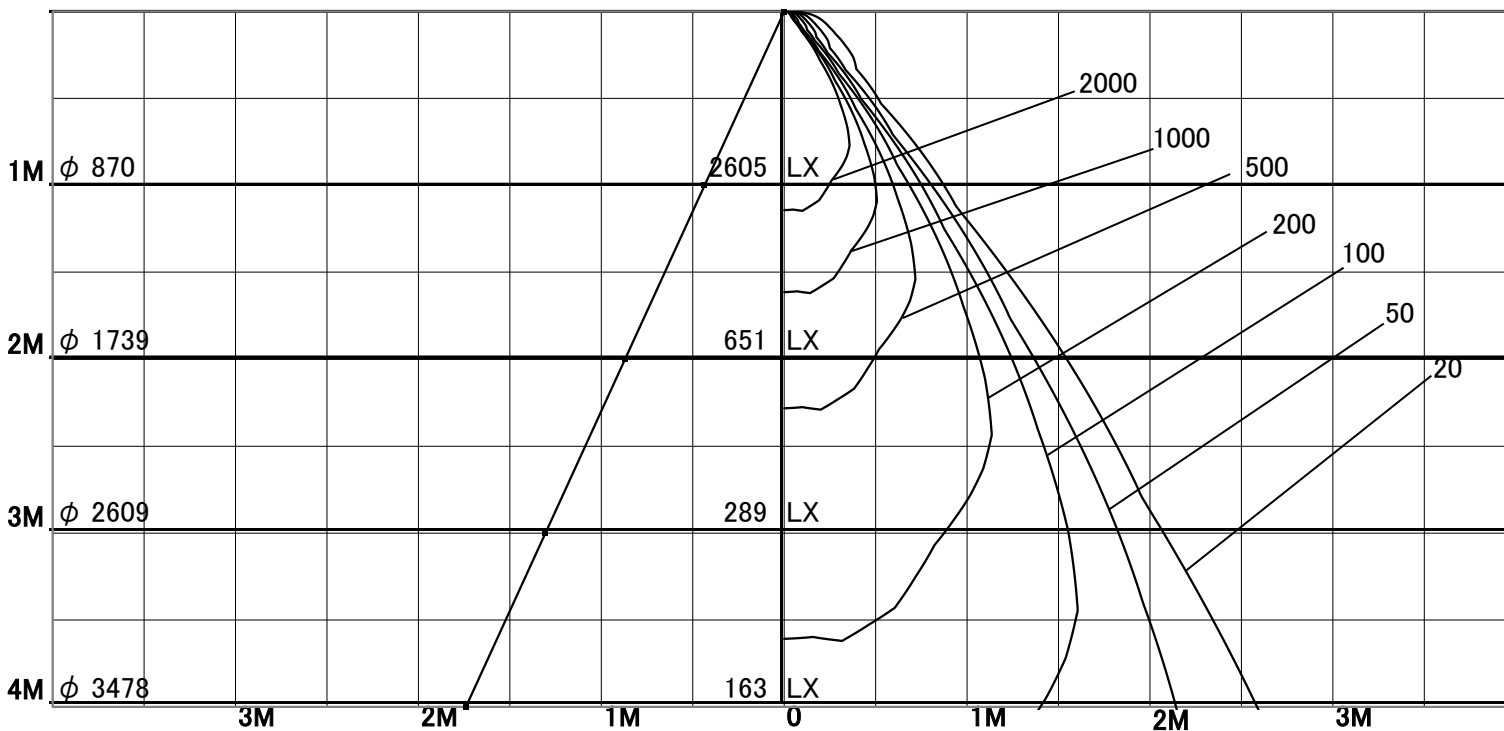

固有照明率表

	80%				70%				50%				30%				0%
	70%	50%	30%	10%	70%	50%	30%	10%	70%	50%	30%	10%	70%	50%	30%	10%	0%
天井	10%																0%
壁	10%																0%
床	10%																0%
0.60	86	80	76	74	85	80	76	74	84	79	76	74	83	79	76	74	73
0.80	90	85	81	79	90	85	81	79	88	84	81	78	87	83	80	78	77
1.00	94	90	86	84	94	89	86	84	92	88	85	83	90	87	85	83	82
1.25	97	93	90	88	96	93	90	87	95	92	89	87	93	90	88	86	85
1.50	99	96	93	91	98	95	93	90	97	94	92	90	95	93	91	89	88
2.00	103	100	98	96	102	99	97	95	100	98	96	95	98	96	95	94	92
2.50	104	102	101	99	104	102	100	99	102	100	99	98	100	99	98	97	95
3.00	106	104	103	102	105	103	102	101	103	102	101	100	101	100	100	99	97
4.00	107	106	105	104	106	105	104	104	104	103	103	102	102	102	101	101	99
5.00	108	107	106	106	107	106	105	105	105	104	104	103	103	103	102	102	100
7.00	108	108	108	108	107	107	107	107	106	105	105	105	104	104	103	103	101
10.00	109	109	109	109	108	108	108	108	106	106	106	106	104	104	104	104	102