

# 屋内照明器具特性

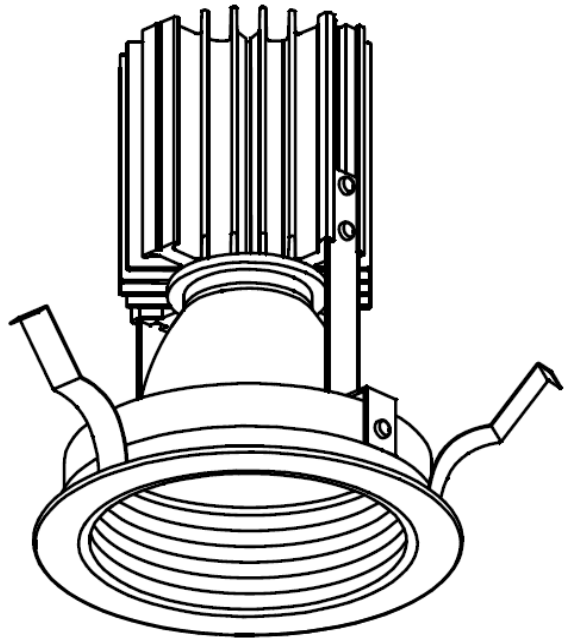

品名	DD-3211-W		
光源	LED30W		
実効光束 (器具光束)	1786lm	エネルギー 効率	59.5lm/W



配光曲線図  
実光度

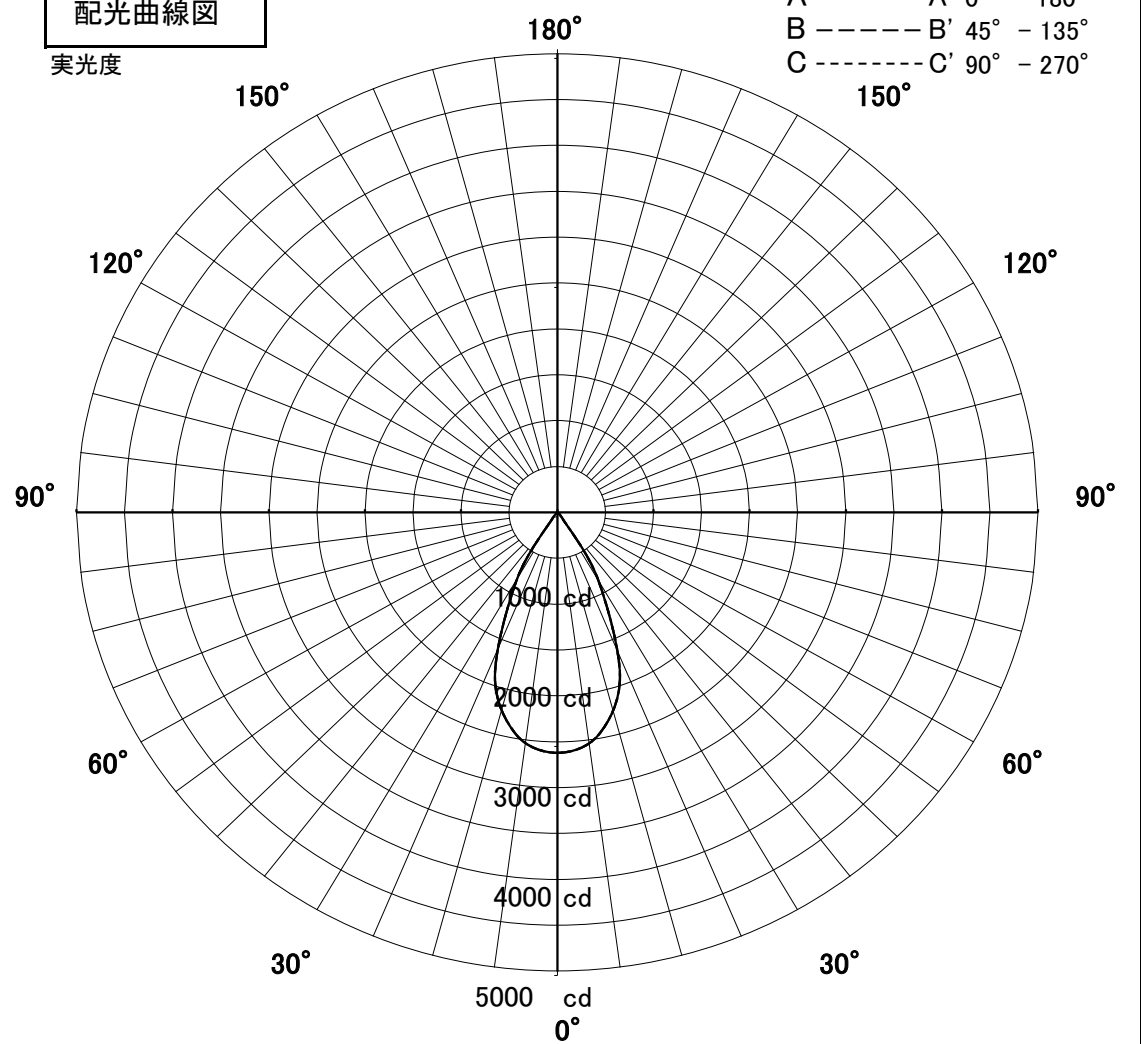

1/2照度角

直射水平面照度

単位: Lx

器具効率	57.8%	
色温度	4000K	
演色評価指数	Ra83	
保守率	良	0.67
	中	0.63
	否	0.56
1/2照度角		
A-A'	47.0	Deg
C-C'	47.0	Deg
最大取付間隔		
A-A'	0.87	H
C-C'	0.87	H

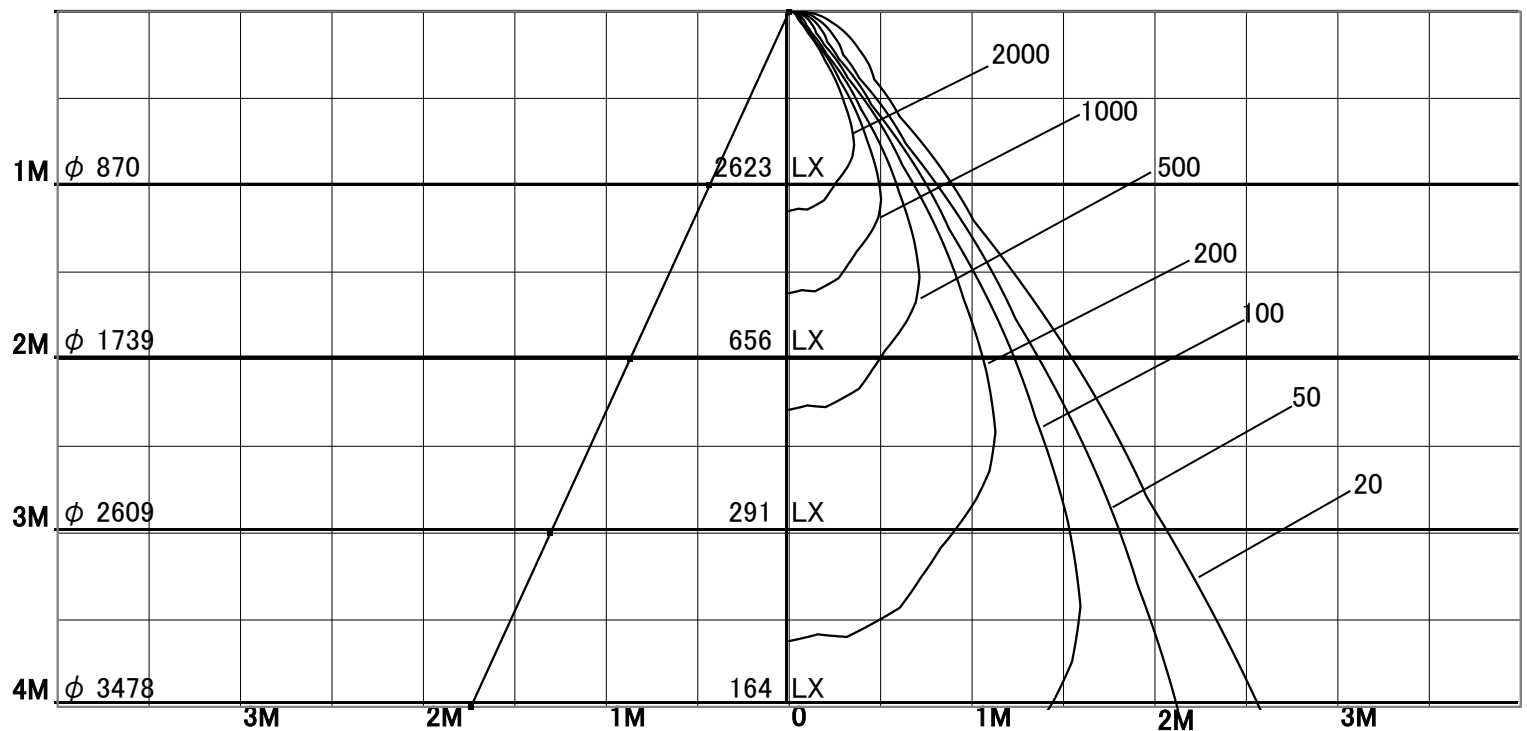

固有照明率表

	80%				70%				50%				30%				0%
	70%	50%	30%	10%	70%	50%	30%	10%	70%	50%	30%	10%	70%	50%	30%	10%	0%
天井	10%																0%
壁	10%																0%
床	10%																0%
0.60	85	79	76	73	84	79	76	73	83	78	75	73	82	78	75	73	72
0.80	90	84	81	78	89	84	81	78	88	83	80	78	86	82	80	77	76
1.00	94	89	86	83	93	89	85	83	91	88	85	83	90	87	84	82	81
1.25	97	93	90	87	96	92	89	87	94	91	88	86	93	90	88	86	84
1.50	99	95	92	90	98	95	92	90	96	93	91	89	94	92	90	89	87
2.00	102	99	97	95	101	99	97	95	99	97	95	94	98	96	94	93	92
2.50	104	102	100	99	103	101	100	98	101	100	98	97	99	98	97	96	94
3.00	105	104	102	101	104	103	102	101	103	101	100	100	101	100	99	98	97
4.00	107	105	105	104	106	105	104	103	104	103	102	102	102	101	101	100	98
5.00	107	106	106	105	106	106	105	104	104	104	103	103	102	102	102	101	99
7.00	108	108	107	107	107	107	106	106	105	105	105	105	103	103	103	103	100
10.00	109	108	108	108	107	107	107	107	106	105	105	105	104	104	104	104	101