

屋内照明器具特性

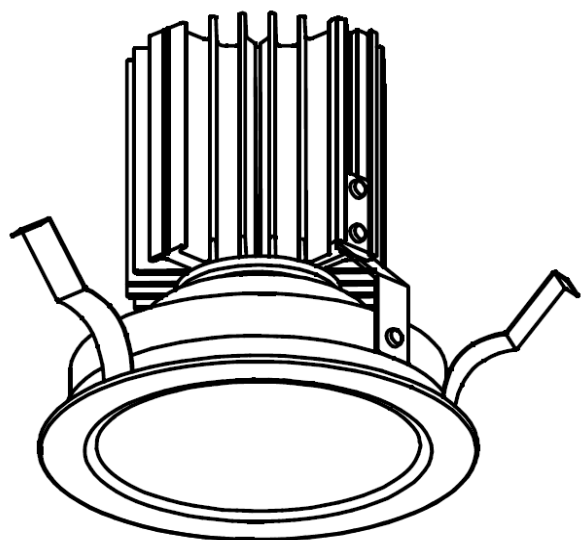

品名	DD-3346-L		
光源	LED30W		
実効光束 (器具光束)	2534lm	エネルギー 効率	84.5lm/W



配光曲線図
実光度

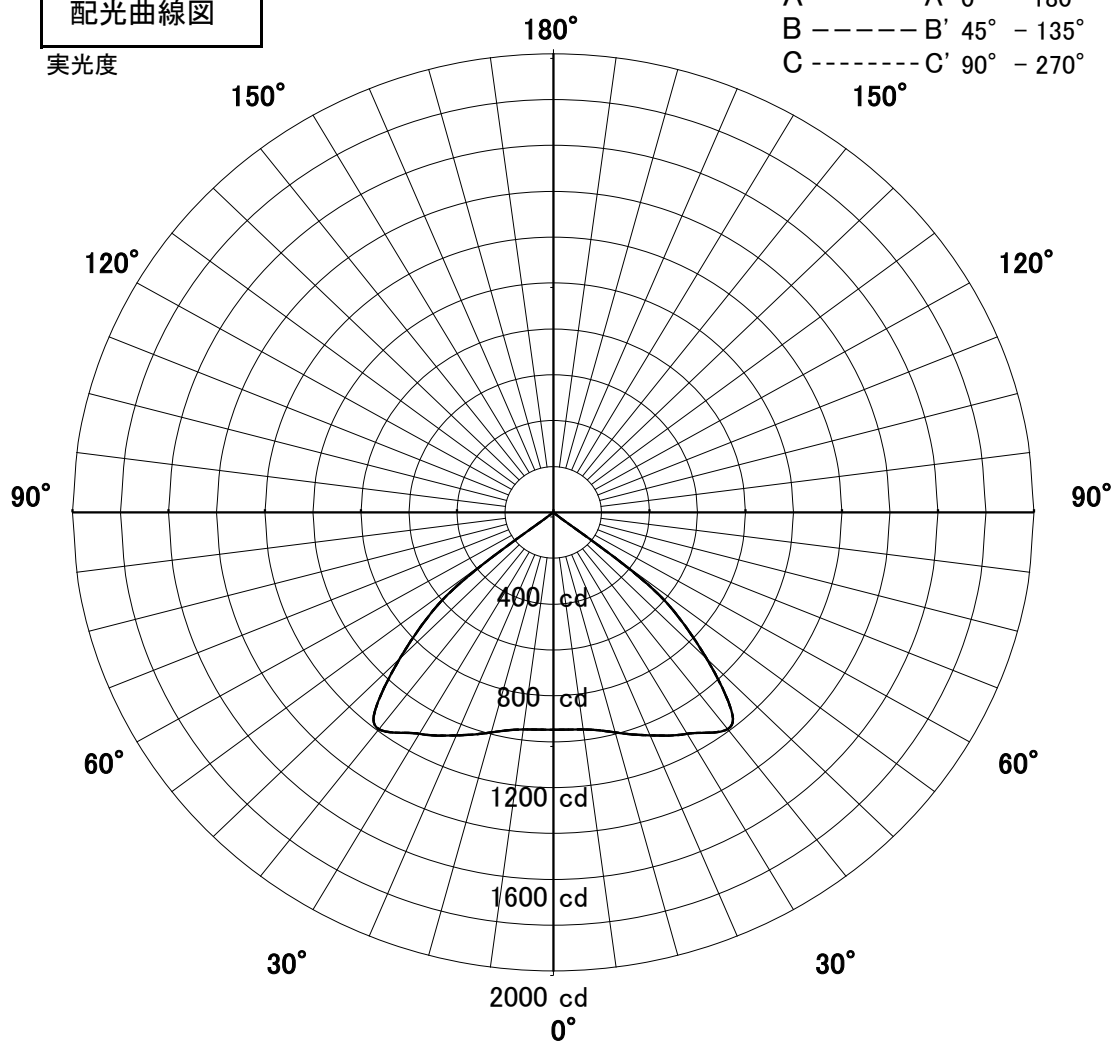

1/2照度角

直射水平面照度

単位: Lx

器具効率	84.7%	
色温度	3000K	
演色評価指数	Ra83	
保守率	良	0.67
	中	0.63
	否	0.56
1/2照度角		
A-A'	83.0	Deg
C-C'	83.0	Deg
最大取付間隔		
A-A'	1.77	H
C-C'	1.77	H

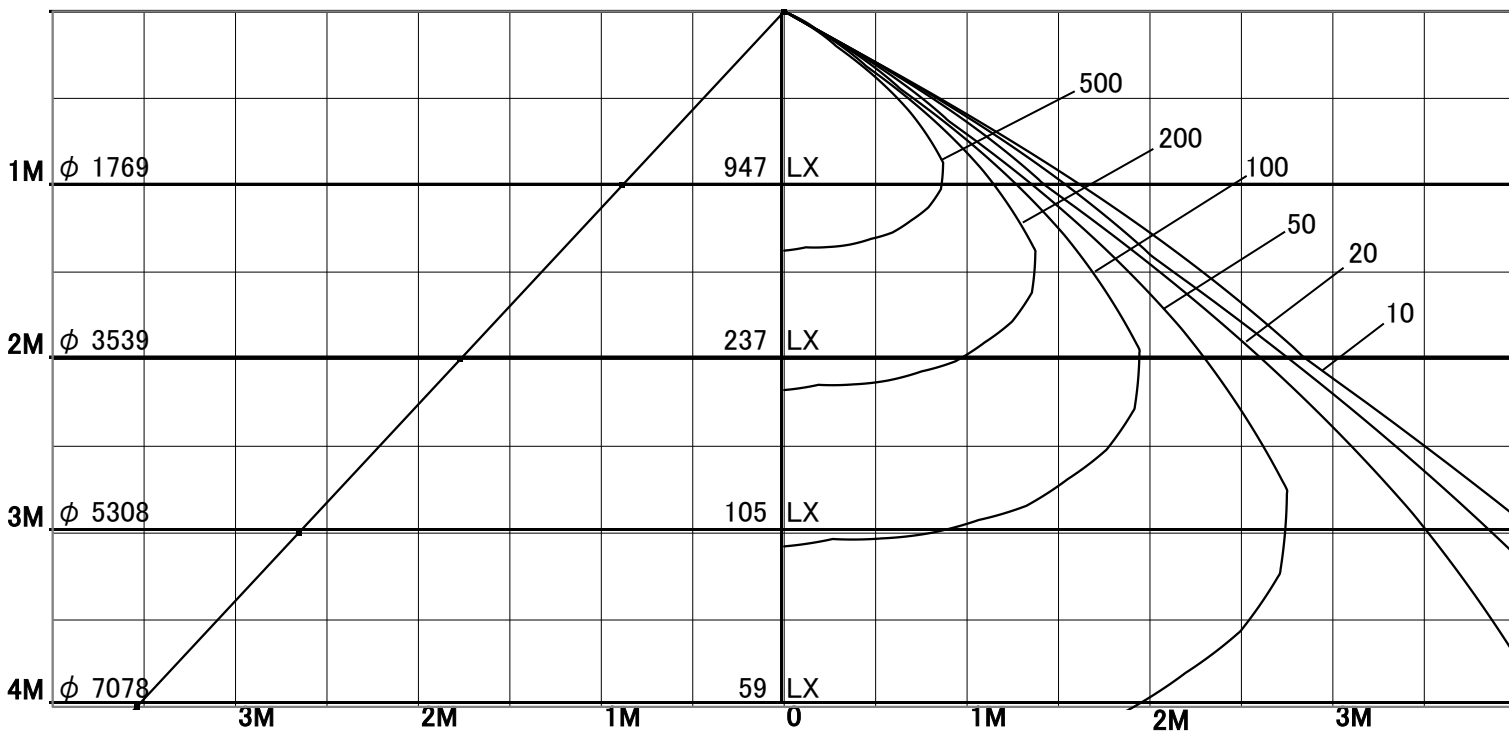

固有照明率表

	80%				70%				50%				30%				0%
	70%	50%	30%	10%	70%	50%	30%	10%	70%	50%	30%	10%	70%	50%	30%	10%	0%
天井	10%																0%
壁	10%																0%
床	10%																0%
0.60	67	56	50	45	66	56	50	45	64	55	49	45	62	54	49	45	43
0.80	77	67	61	56	75	67	61	56	73	65	60	56	71	64	59	56	54
1.00	84	75	69	65	82	75	69	65	80	73	68	65	78	72	68	64	62
1.25	89	82	77	73	88	82	77	73	86	80	76	72	83	79	75	72	70
1.50	93	87	82	79	92	86	82	78	89	85	81	78	87	83	80	77	75
2.00	98	93	90	87	97	93	89	86	94	91	88	85	92	89	87	84	82
2.50	101	97	94	91	100	96	93	91	97	94	92	90	95	93	91	89	87
3.00	102	99	97	94	101	98	96	94	99	97	94	93	97	95	93	91	89
4.00	104	102	99	97	103	101	99	97	101	99	97	95	98	97	95	94	92
5.00	105	103	101	99	104	102	100	98	101	100	98	97	99	98	97	95	93
7.00	106	104	103	101	105	103	102	100	102	101	100	99	100	99	98	97	94
10.00	107	105	104	103	106	104	103	102	103	102	101	100	101	100	99	98	95