

屋内照明器具特性

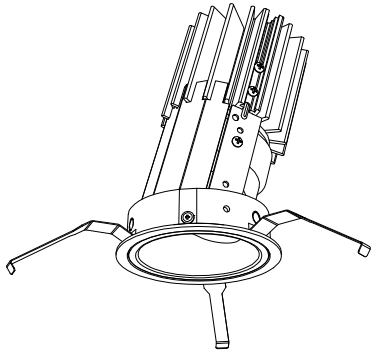

品名	DD-3494-N		
光源	LED19.8W		
実効光束 (器具光束)	1120lm	エネルギー 効率	56.5lm/W



配光曲線図

実光度

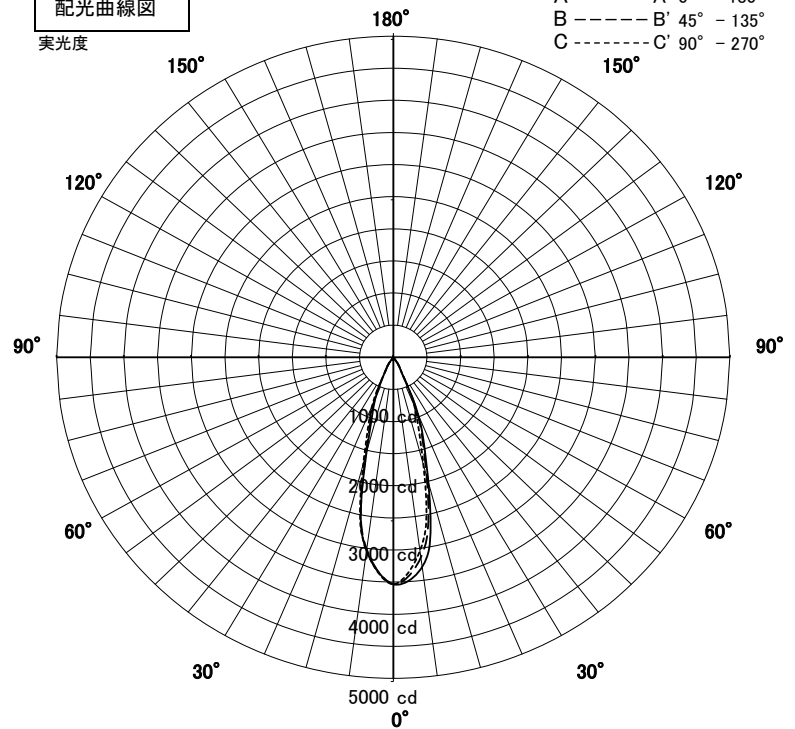

1/2照度角

直射水平面照度

単位:Lx

器具効率	45.0%	
色温度	5000K	
演色評価指数	Ra83	
保守率	良	0.67
	中	0.63
	否	0.56
1/2照度角		
A-A'	29.5	Deg
C-C'	29.5	Deg
最大取付間隔		
A-A'	0.53	H
C-C'	0.53	H

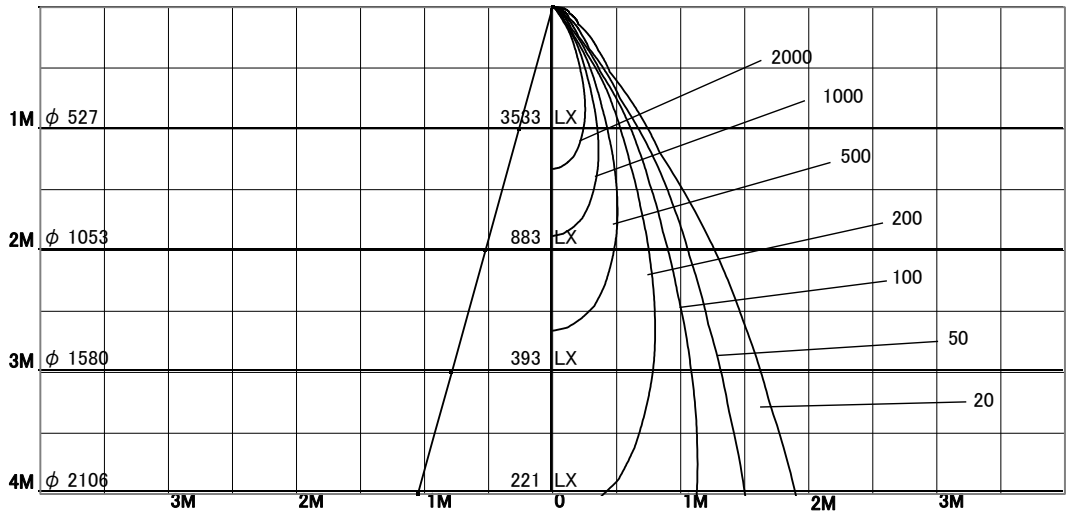

固有照明率表

天井	80%				70%				50%				30%				0%
	70%	50%	30%	10%	70%	50%	30%	10%	70%	50%	30%	10%	70%	50%	30%	10%	0%
壁	10%																0%
床	10%																0%
0.60	89	84	80	77	89	83	80	77	87	83	80	77	86	82	79	77	76
0.80	94	89	85	82	93	88	85	82	92	87	84	82	90	87	84	82	81
1.00	98	93	90	88	97	93	90	87	96	92	89	87	94	91	89	87	85
1.25	101	97	94	92	100	96	94	91	98	95	93	91	97	94	92	90	89
1.50	103	100	97	95	102	99	96	94	100	98	95	94	99	96	94	93	91
2.00	106	104	102	100	105	103	101	99	104	102	100	98	102	100	99	98	96
2.50	108	106	105	103	107	106	104	103	106	104	103	102	104	103	102	101	99
3.00	110	108	107	106	109	107	106	105	107	106	105	104	105	104	104	103	101
4.00	111	110	109	108	110	109	108	108	108	107	107	106	106	106	105	105	103
5.00	112	111	110	110	111	110	109	109	109	108	108	107	107	106	106	106	104
7.00	112	112	112	112	111	111	111	111	109	109	109	109	107	107	107	107	105
10.00	113	113	113	113	112	112	112	112	110	110	110	110	108	108	108	108	105