

# 屋内照明器具特性

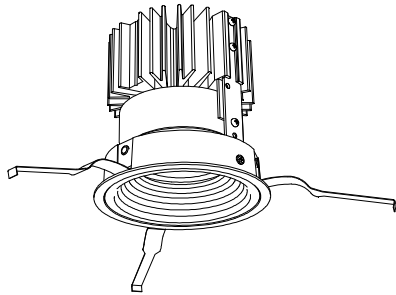

品名	DD-3503-L		
光源	LED27.0W		
実効光束 (器具光束)	2232lm	効率	82.6lm/W



配光曲線図

実光度

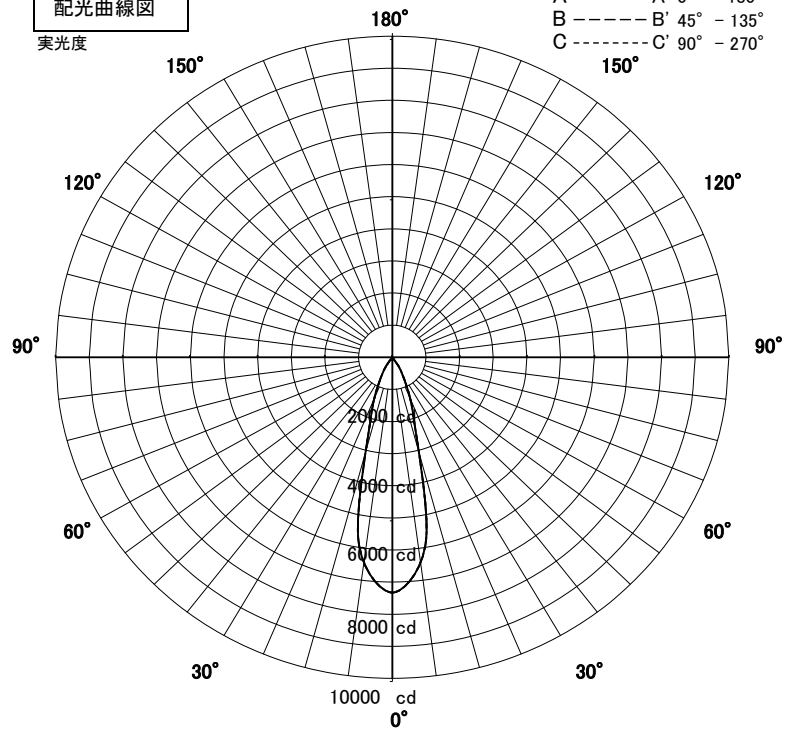

1/2照度角

直射水平面照度

単位:Lx

器具効率	67.9%	
色温度	3000K	
演色評価指数	Ra83	
保守率	良	0.67
	中	0.63
	否	0.56

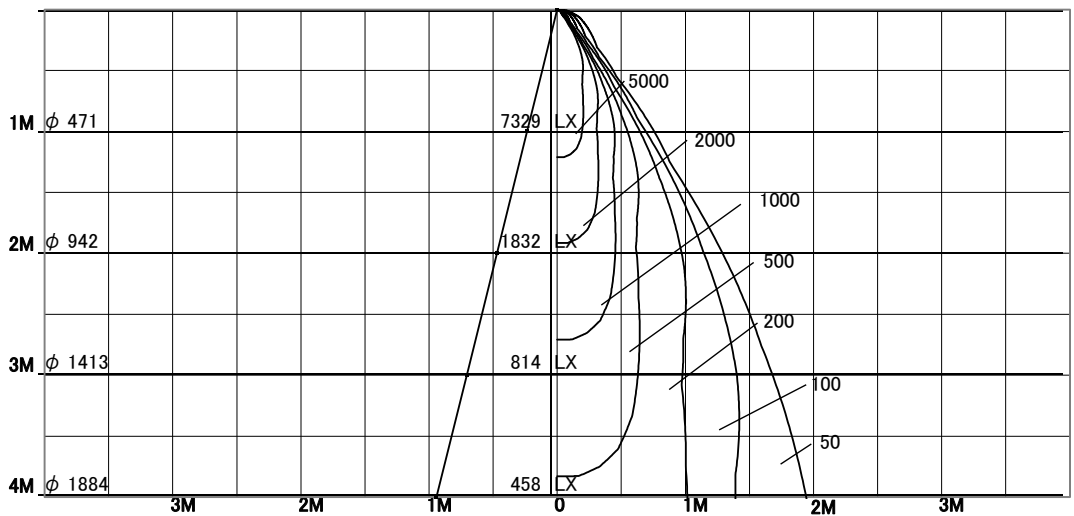

照明率表

天井	80%				70%				50%				30%				0%
	70%	50%	30%	10%	70%	50%	30%	10%	70%	50%	30%	10%	70%	50%	30%	10%	0%
壁	10%																0%
床	10%																0%
0.60	53	50	48	46	53	50	48	46	52	49	47	46	52	49	47	46	45
0.80	56	53	51	49	56	53	51	49	55	52	50	49	54	52	50	49	48
1.00	59	56	54	52	58	56	54	52	57	55	53	52	56	54	53	52	51
1.25	61	58	56	55	60	58	56	55	59	57	55	54	58	56	55	54	53
1.50	62	60	58	56	61	59	58	56	60	58	57	56	59	58	56	55	55
2.00	64	62	61	60	63	62	60	59	62	61	60	59	61	60	59	58	57
2.50	65	64	63	62	64	63	62	62	63	62	62	61	62	61	61	60	59
3.00	66	65	64	63	65	64	64	63	64	63	63	62	63	62	62	62	60
4.00	66	66	65	65	66	65	65	64	65	64	64	64	64	63	63	63	61
5.00	67	66	66	66	66	66	66	65	65	65	65	64	64	64	64	63	62
7.00	67	67	67	67	67	67	67	66	66	65	65	65	64	64	64	64	63
10.00	68	68	68	68	67	67	67	67	66	66	66	66	65	65	65	65	63