

屋内照明器具特性

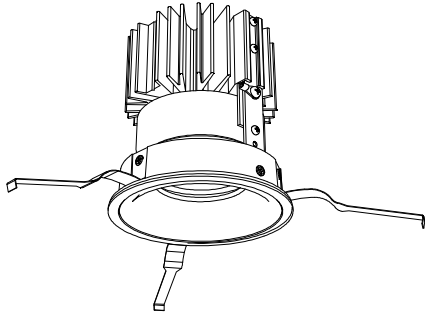

品名	DD-3511-W		
光源	LED27.0W		
実効光束 (器具光束)	2307lm	効率	85.4lm/W



配光曲線図

実光度

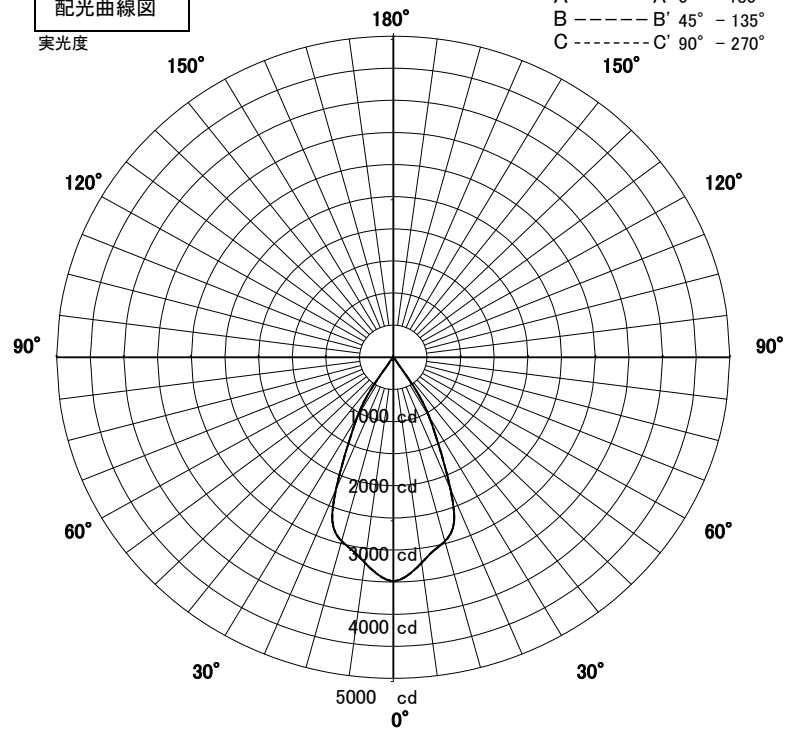

1/2照度角

直射水平面照度

単位: Lx

器具効率	66.7%
色温度	4000K
演色評価指数	Ra83
保守率	良 0.63
	中 0.6
	否 0.56

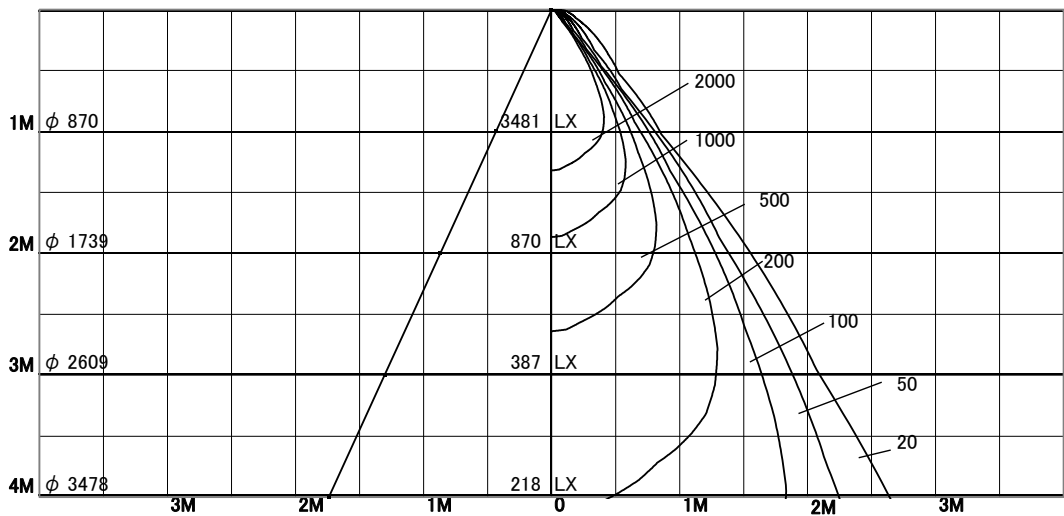

照明率表

天井	80%				70%				50%				30%				0%
	70%	50%	30%	10%	70%	50%	30%	10%	70%	50%	30%	10%	70%	50%	30%	10%	0%
壁	10%																0%
床	10%																0%
0.60	48	45	43	41	48	45	43	41	47	44	43	41	46	44	42	41	41
0.80	51	48	46	44	50	47	45	44	49	47	45	44	49	46	45	44	43
1.00	53	50	48	47	52	50	48	47	51	49	48	47	51	49	47	46	46
1.25	54	52	50	49	54	52	50	49	53	51	50	49	52	51	49	48	48
1.50	56	54	52	51	55	53	52	51	54	52	51	50	53	52	51	50	49
2.00	57	56	55	54	57	55	54	53	56	55	54	53	55	54	53	52	52
2.50	58	57	56	56	58	57	56	55	57	56	55	55	56	55	55	54	53
3.00	59	58	58	57	59	58	57	57	58	57	56	56	57	56	56	55	54
4.00	60	59	59	58	59	59	58	58	58	58	57	57	57	57	57	56	55
5.00	60	60	59	59	60	59	59	59	58	58	58	58	57	57	57	57	56
7.00	61	60	60	60	60	60	60	60	59	59	59	59	58	58	58	58	56
10.00	61	61	61	61	60	60	60	60	59	59	59	59	58	58	58	58	57