

屋内照明器具特性



品名	DD-3518-L		
光源	LED27.0W		
実効光束 (器具光束)	2150lm	エネルギー 効率	79.6lm/W

配光曲線図

実光度

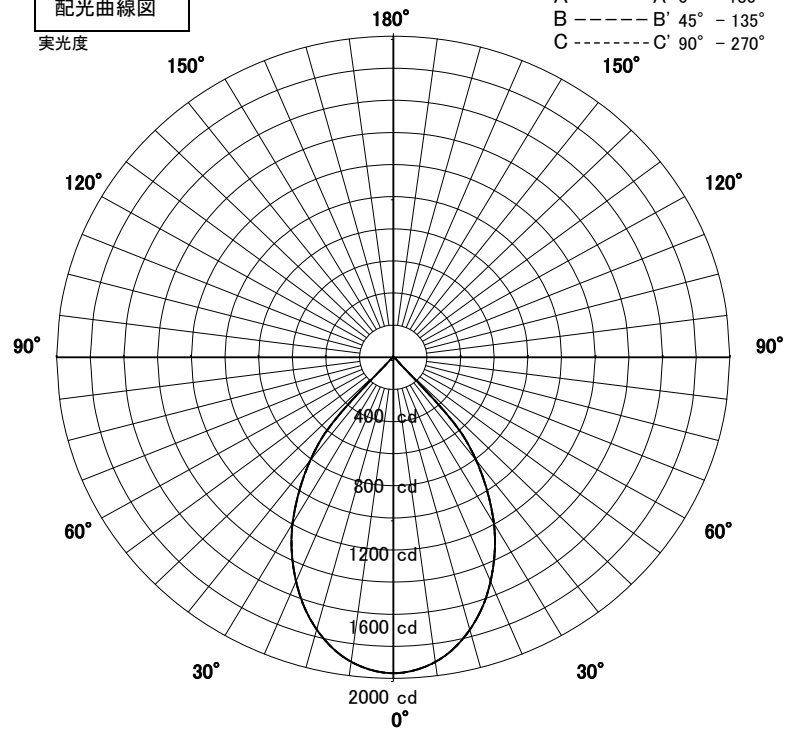

1/2照度角

直射水平面照度

単位:Lx

器具効率	88.1%	
色温度	3000K	
演色評価指数	Ra95	
保守率	良	0.67
	中	0.63
	否	0.56
1/2照度角		
A-A'	52.0	Deg
C-C'	52.0	Deg
最大取付間隔		
A-A'	0.98	H
C-C'	0.98	H

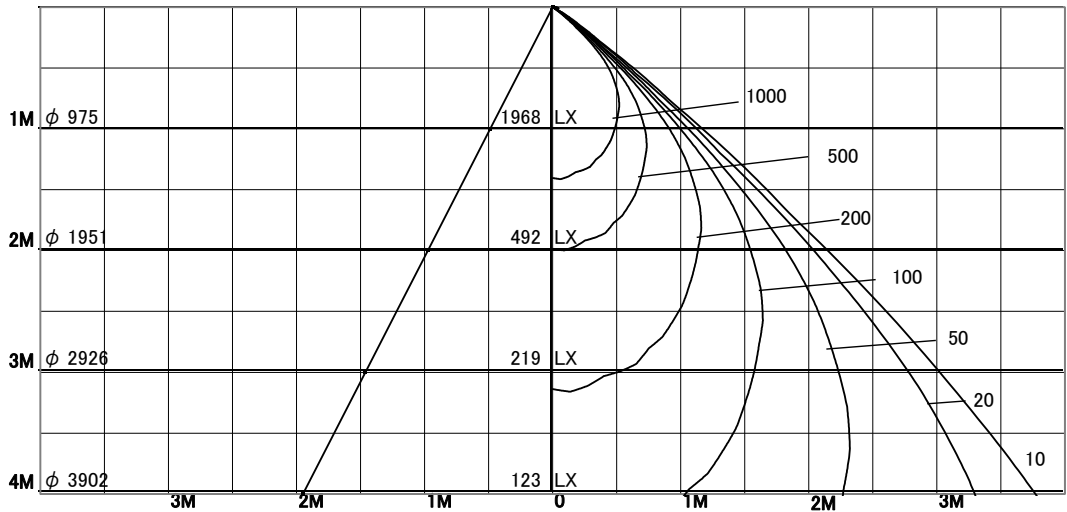

固有照明率表

天井	80%				70%				50%				30%				0%
	70%	50%	30%	10%	70%	50%	30%	10%	70%	50%	30%	10%	70%	50%	30%	10%	0%
壁	10%																0%
床	10%																0%
0.60	81	74	70	67	80	74	70	67	79	73	69	67	78	73	69	67	65
0.80	87	81	77	73	86	80	76	73	85	79	76	73	83	79	75	73	72
1.00	92	86	82	79	91	86	82	79	89	85	81	79	88	84	81	79	77
1.25	96	91	87	84	95	90	87	84	93	89	86	84	91	88	85	83	82
1.50	98	94	91	88	97	93	90	88	95	92	89	87	93	91	88	87	85
2.00	102	99	96	94	101	98	96	94	99	96	94	93	97	95	93	92	90
2.50	104	101	99	98	103	101	99	97	101	99	98	96	99	98	96	95	93
3.00	105	103	102	100	104	103	101	100	102	101	100	99	100	99	98	97	95
4.00	107	105	104	103	105	104	103	102	104	103	102	101	102	101	100	99	97
5.00	107	106	105	104	106	105	104	104	104	103	103	102	102	102	101	101	98
7.00	108	107	107	106	107	106	106	105	105	105	104	104	103	103	102	102	100
10.00	109	108	108	108	108	107	107	107	105	105	105	105	103	103	103	103	100