

# 屋内照明器具特性

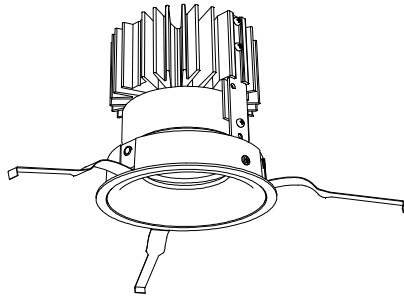

品名	DD-3522-L		
光源	LED27.0W		
実効光束 (器具光束)	1734lm	効率	64.2lm/W



配光曲線図

実光度

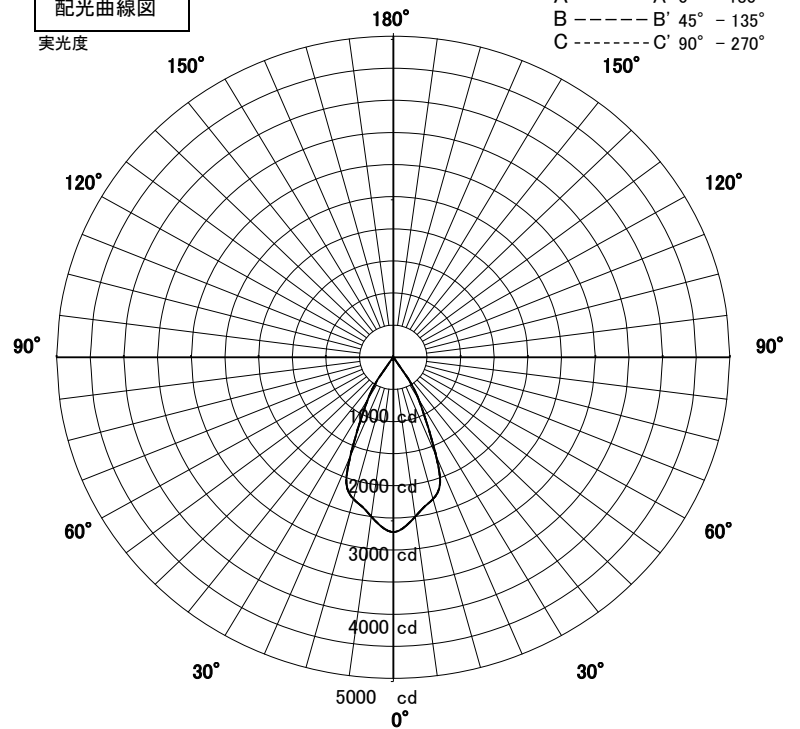

1/2照度角

直射水平面照度

単位: Lx

器具効率	71.2%	
色温度	3000K	
演色評価指数	Ra95	
保守率	良	0.67
	中	0.63
	否	0.56

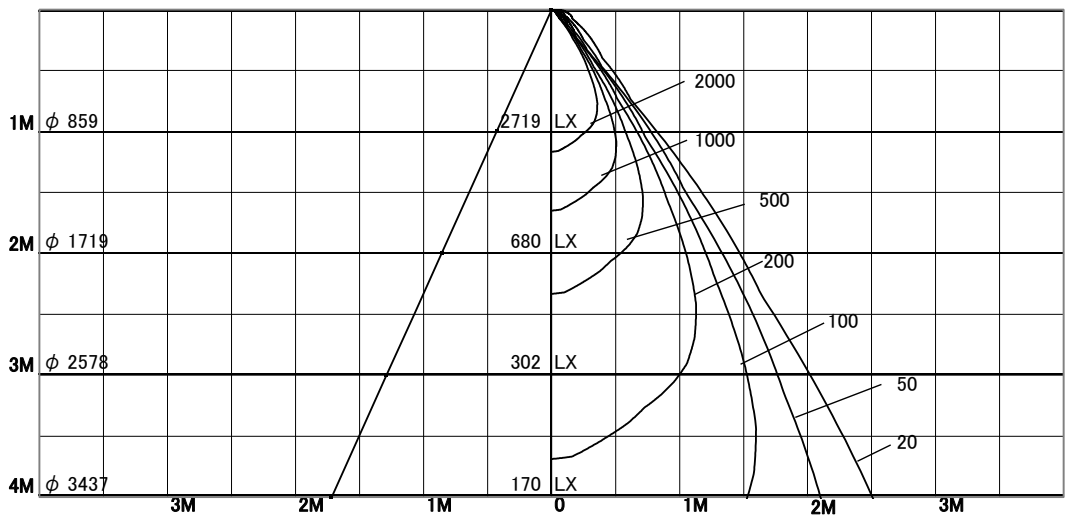

照明率表

天井	80%				70%				50%				30%				0%
	70%	50%	30%	10%	70%	50%	30%	10%	70%	50%	30%	10%	70%	50%	30%	10%	0%
壁	10%																0%
床	10%																0%
0.60	51	47	45	44	50	47	45	44	49	47	45	44	49	46	45	44	43
0.80	53	50	48	47	53	50	48	47	52	49	48	46	51	49	47	46	46
1.00	56	53	51	50	55	53	51	49	54	52	50	49	53	51	50	49	48
1.25	57	55	53	52	57	55	53	52	56	54	52	51	55	53	52	51	50
1.50	58	56	55	54	58	56	55	53	57	55	54	53	56	55	53	53	52
2.00	60	59	58	57	60	58	57	56	59	58	57	56	58	57	56	55	54
2.50	61	60	59	59	61	60	59	58	60	59	58	58	59	58	58	57	56
3.00	62	61	61	60	62	61	60	60	61	60	59	59	60	59	59	58	57
4.00	63	62	62	61	62	62	61	61	61	61	60	60	60	60	60	59	58
5.00	63	63	63	62	63	62	62	62	62	61	61	61	60	60	60	60	59
7.00	64	64	63	63	63	63	63	63	62	62	62	62	61	61	61	61	59
10.00	64	64	64	64	63	63	63	63	62	62	62	62	61	61	61	61	60