

屋内照明器具特性



品名	DD-3538-WW		
光源	LED19.8W		
実効光束 (器具光束)	1239lm	エネルギー 効率	62.5lm/W

配光曲線図

実光度

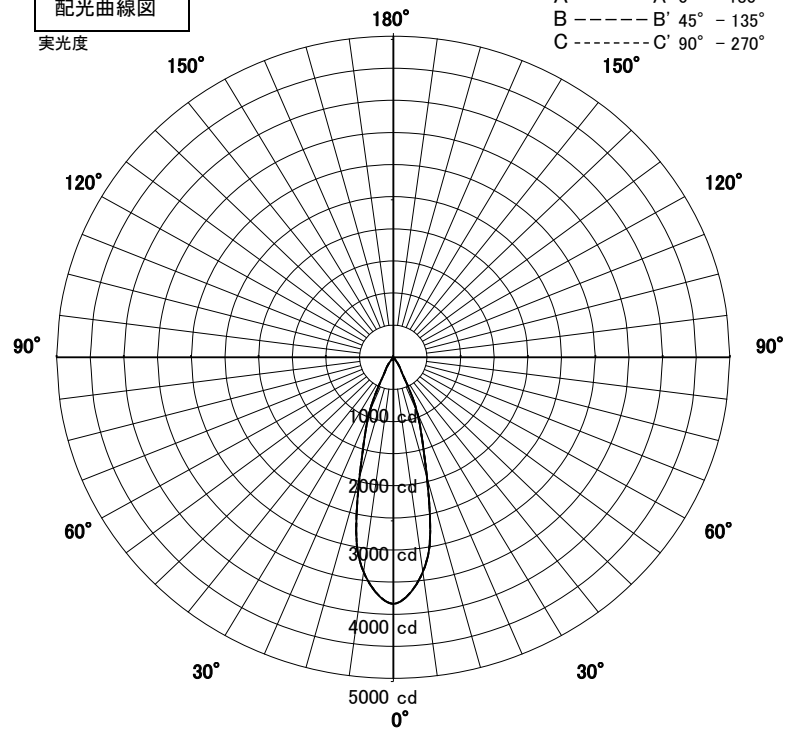

1/2照度角

直射水平面照度

単位:Lx

器具効率	51.0%	
色温度	3500K	
演色評価指数	Ra83	
保守率	良	0.67
	中	0.63
	否	0.56
1/2照度角		
A-A'	29.5	Deg
C-C'	29.5	Deg
最大取付間隔		
A-A'	0.53	H
C-C'	0.53	H

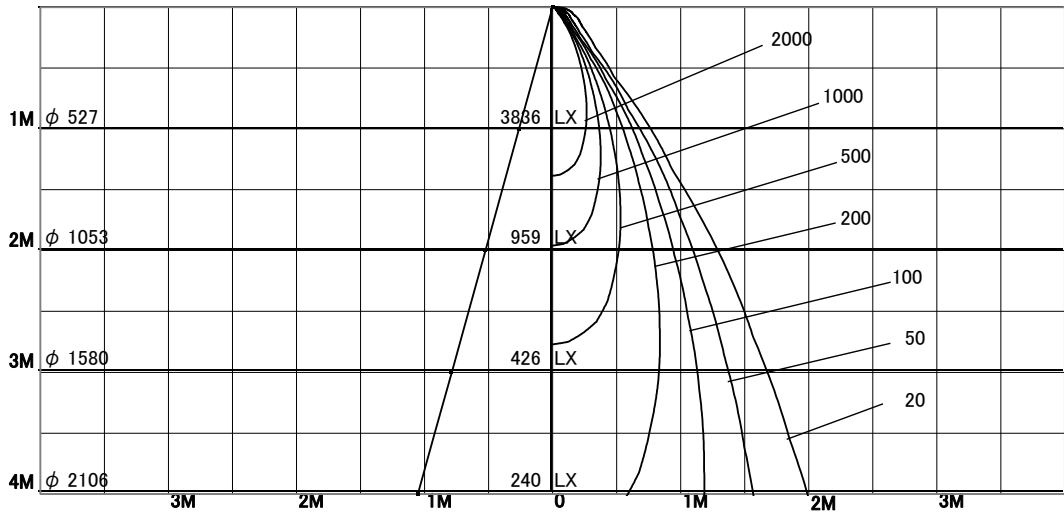

固有照明率表

天井	80%				70%				50%				30%				0%
	70%	50%	30%	10%	70%	50%	30%	10%	70%	50%	30%	10%	70%	50%	30%	10%	0%
壁	10%																
床	10%																
0.60	89	83	79	77	88	83	79	77	87	82	79	77	86	82	79	77	76
0.80	94	88	84	82	93	88	84	82	91	87	84	81	90	86	83	81	80
1.00	98	93	89	87	97	92	89	87	95	91	88	86	94	90	88	86	85
1.25	100	96	93	91	100	96	93	91	98	95	92	90	96	93	91	90	88
1.50	103	99	96	94	102	98	96	94	100	97	95	93	98	96	94	92	91
2.00	106	103	101	99	105	102	100	99	103	101	99	98	101	100	98	97	95
2.50	108	106	104	103	107	105	103	102	105	103	102	101	103	102	101	100	98
3.00	109	108	106	105	108	107	106	105	106	105	104	103	104	104	103	102	100
4.00	110	109	108	108	109	108	108	107	107	107	106	105	105	105	104	104	102
5.00	111	110	110	109	110	109	109	108	108	107	107	107	106	106	105	105	103
7.00	112	111	111	111	111	110	110	110	109	109	108	108	107	107	107	107	104
10.00	112	112	112	112	111	111	111	111	109	109	109	109	107	107	107	107	105