

屋内照明器具特性

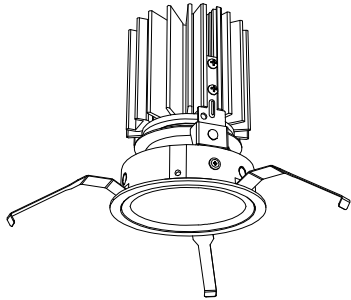

品名	DD-3541-L		
光源	LED 19.8W		
実効光束 (器具光束)	1494lm	エネルギー 効率	75.4lm/W



配光曲線図

実光度

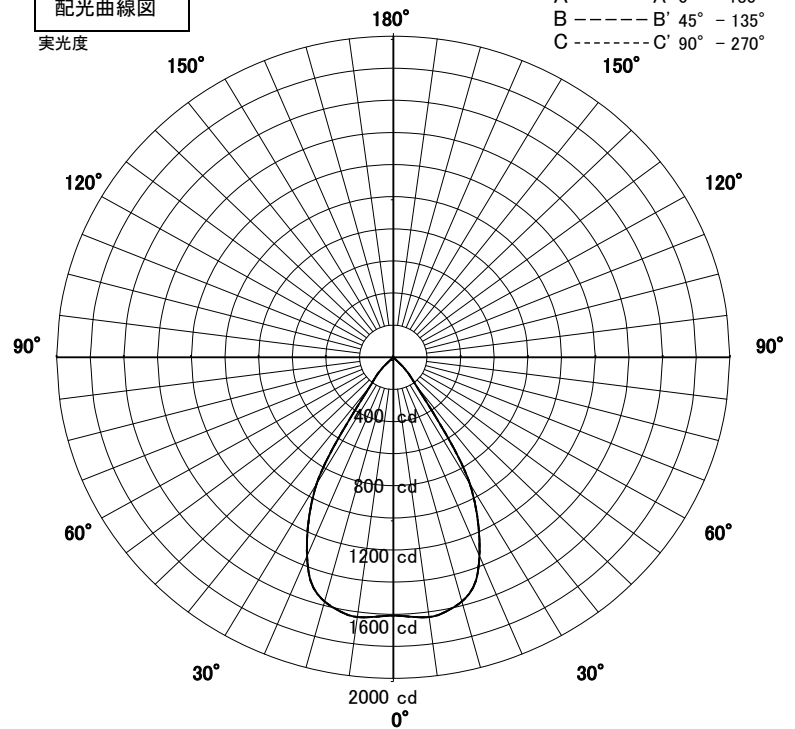

1/2照度角

直射水平面照度

単位:Lx

器具効率	85.9%	
色温度	3000K	
演色評価指数	Ra95	
保守率	良	0.67
	中	0.63
	否	0.56
1/2照度角		
A-A'	53.5	Deg
C-C'	53.5	Deg
最大取付間隔		
A-A'	1.01	H
C-C'	1.01	H

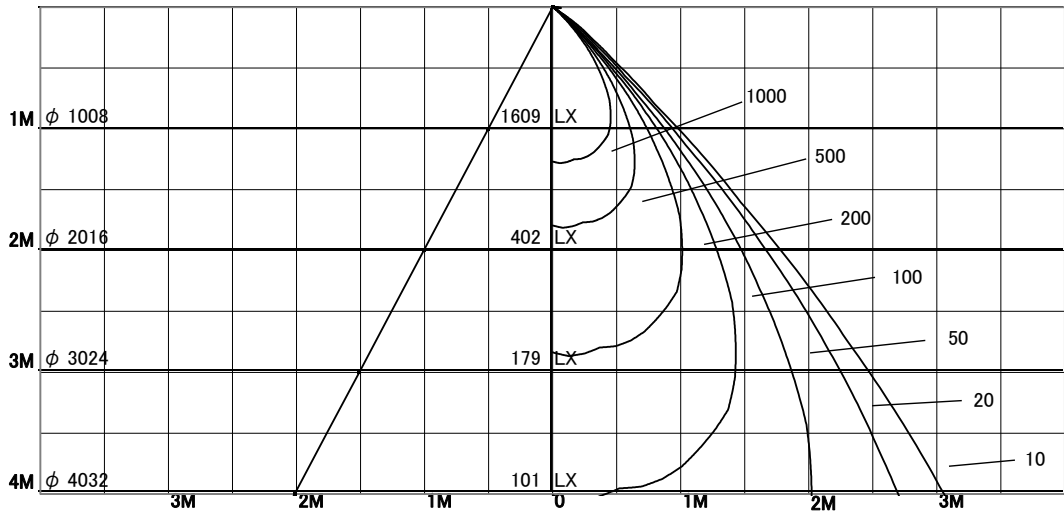

固有照明率表

天井	80%				70%				50%				30%				0%
	70%	50%	30%	10%	70%	50%	30%	10%	70%	50%	30%	10%	70%	50%	30%	10%	0%
壁	10%																0%
床	10%																0%
0.60	86	80	76	73	85	80	76	73	84	79	76	73	83	78	75	73	72
0.80	91	85	82	79	90	85	81	79	89	84	81	78	87	83	80	78	77
1.00	95	90	87	84	94	90	86	84	93	89	86	84	91	88	85	83	82
1.25	98	94	91	88	97	93	90	88	96	92	90	88	94	91	89	87	86
1.50	100	97	94	92	99	96	93	91	98	95	92	91	96	94	92	90	88
2.00	104	101	99	97	103	100	98	96	101	99	97	96	99	97	96	95	93
2.50	106	104	102	100	105	103	101	100	103	101	100	99	101	100	99	98	96
3.00	107	105	104	103	106	105	103	102	104	103	102	101	102	102	101	100	98
4.00	108	107	106	105	107	106	105	105	105	105	104	103	103	103	102	102	100
5.00	109	108	107	107	108	107	107	106	106	105	105	105	104	104	103	103	101
7.00	110	109	109	109	109	108	108	108	107	106	106	106	105	105	105	104	102
10.00	110	110	110	110	109	109	109	109	107	107	107	107	105	105	105	105	103