

# 屋内照明器具特性

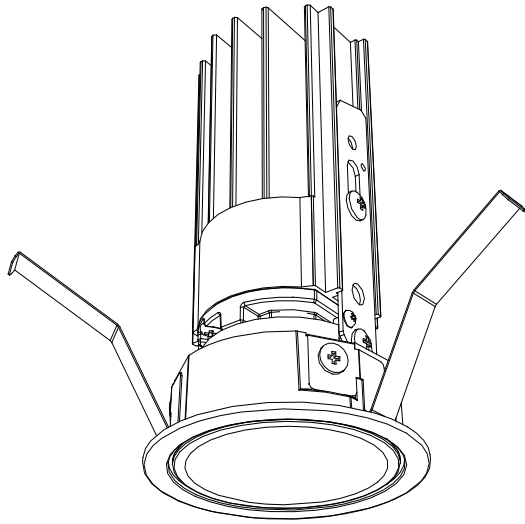

品名	DD-3575-N		
光源	LED10.3W		
実効光束 (器具光束)	616lm	エネルギー 効率	59.8lm/W



配光曲線図  
実光度

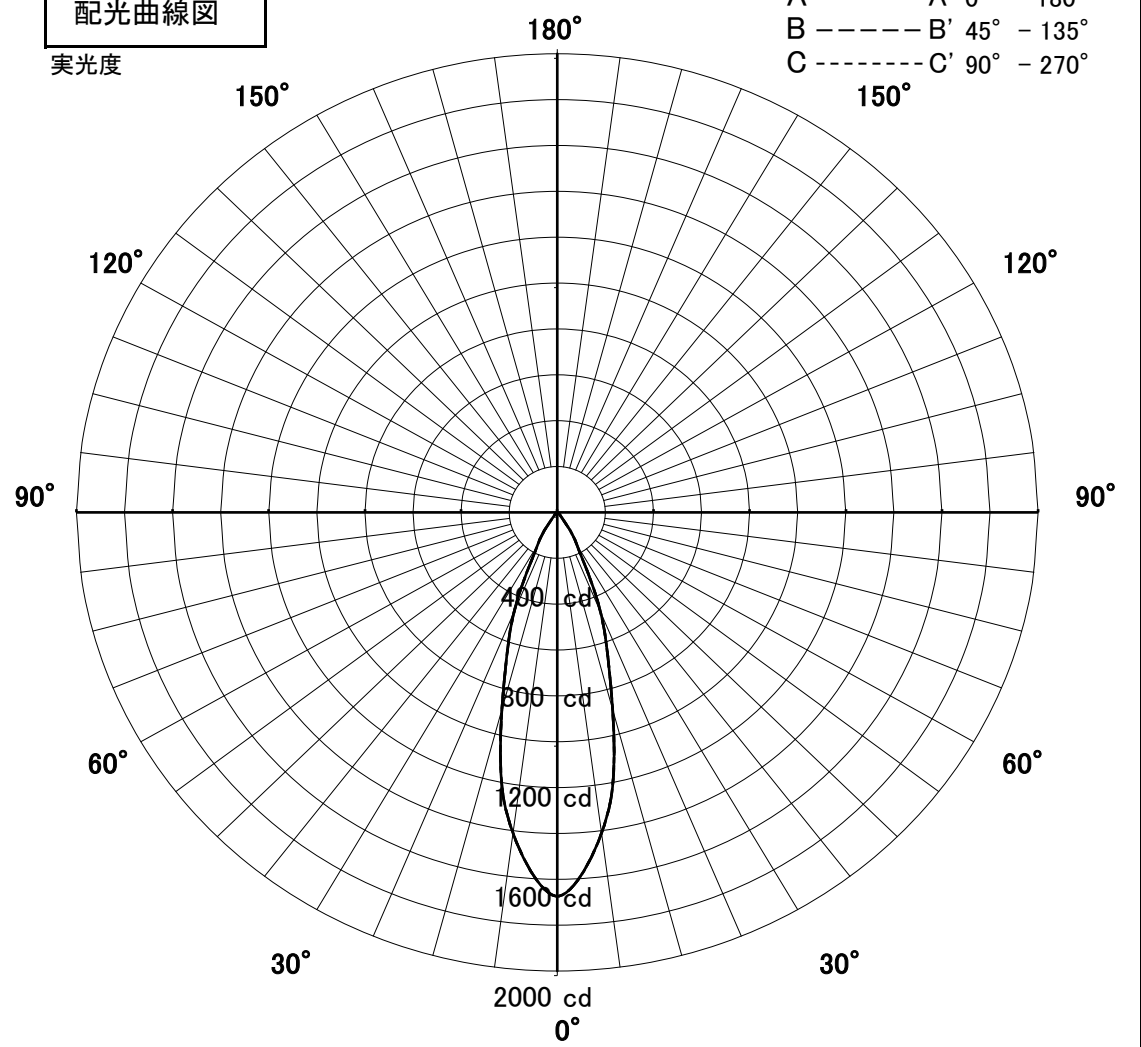

1/2照度角

直射水平面照度

単位: Lx

器具効率	55.8%	
色温度	5000K	
演色評価指数	Ra83	
保守率	良	0.67
	中	0.63
	否	0.56
1/2照度角		
A-A'	29.5	Deg
C-C'	29.5	Deg
最大取付間隔		
A-A'	0.53	H
C-C'	0.53	H

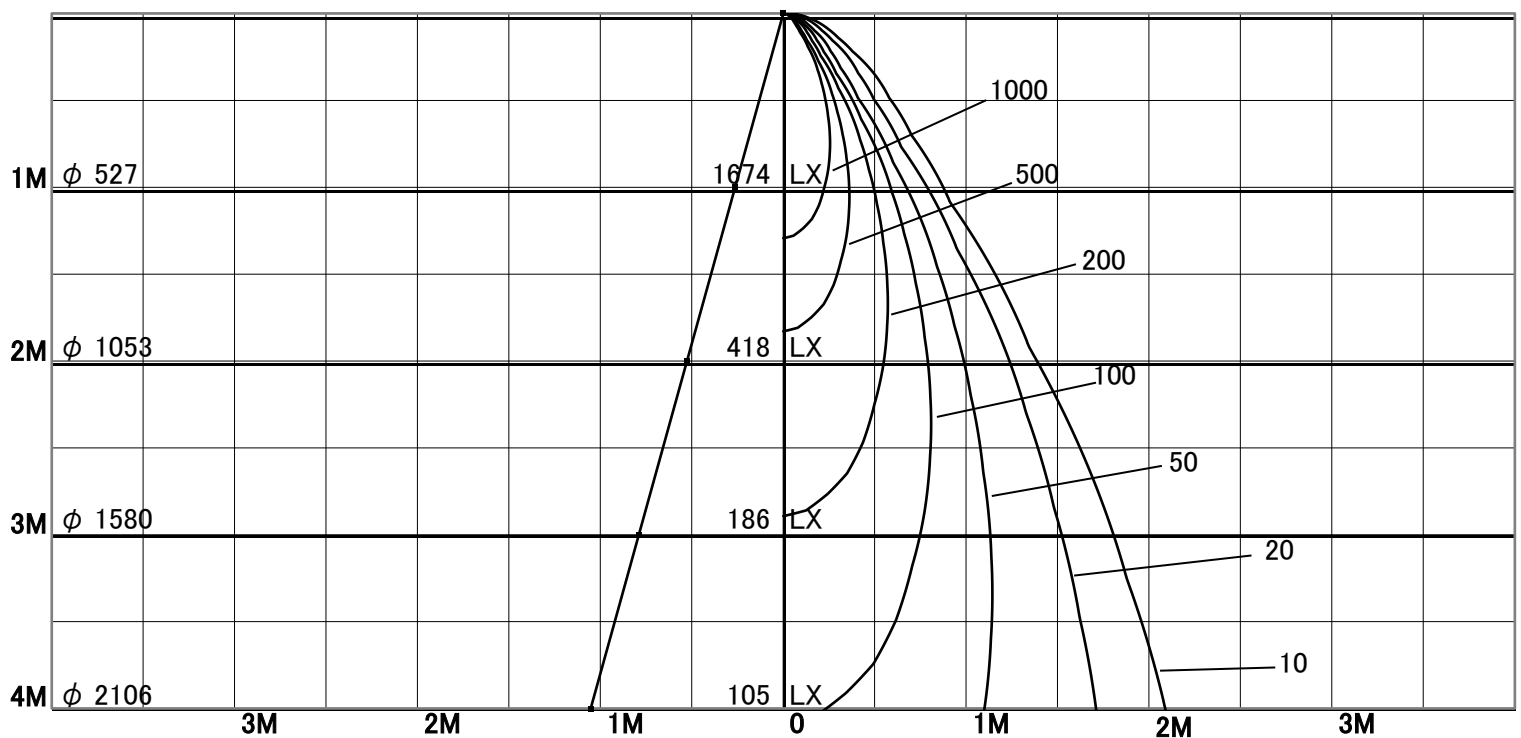

固有照明率表

	80%				70%				50%				30%				0%
	70%	50%	30%	10%	70%	50%	30%	10%	70%	50%	30%	10%	70%	50%	30%	10%	0%
天井	10%																0%
壁	10%																0%
床	10%																0%
0.60	86	80	77	74	86	80	76	74	84	79	76	74	83	79	76	74	73
0.80	91	86	82	79	90	85	82	79	89	84	81	79	87	84	81	78	77
1.00	95	91	87	84	95	90	87	84	93	89	86	84	91	88	85	83	82
1.25	99	94	91	89	98	94	91	88	96	92	90	88	94	91	89	87	86
1.50	101	97	94	92	100	96	94	91	98	95	93	91	96	94	92	90	88
2.00	104	101	99	97	103	100	98	97	101	99	97	96	99	98	96	95	93
2.50	106	104	102	101	105	103	102	100	103	102	100	99	101	100	99	98	96
3.00	107	106	104	103	106	105	104	103	105	103	102	101	103	102	101	100	98
4.00	109	108	107	106	108	107	106	105	106	105	104	104	104	103	103	102	100
5.00	109	109	108	107	108	108	107	106	106	106	105	105	105	104	104	103	101
7.00	110	110	110	109	109	109	109	108	107	107	107	107	105	105	105	105	102
10.00	111	111	111	110	110	110	110	109	108	108	108	108	106	106	106	106	103