

屋内照明器具特性

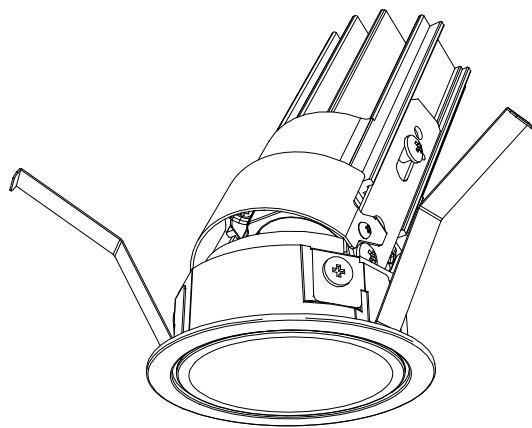

品名	DD-3578-N		
光源	LED10.3W		
実効光束 (器具光束)	131lm	エネルギー 効率	12.7lm/W



配光曲線図
実光度

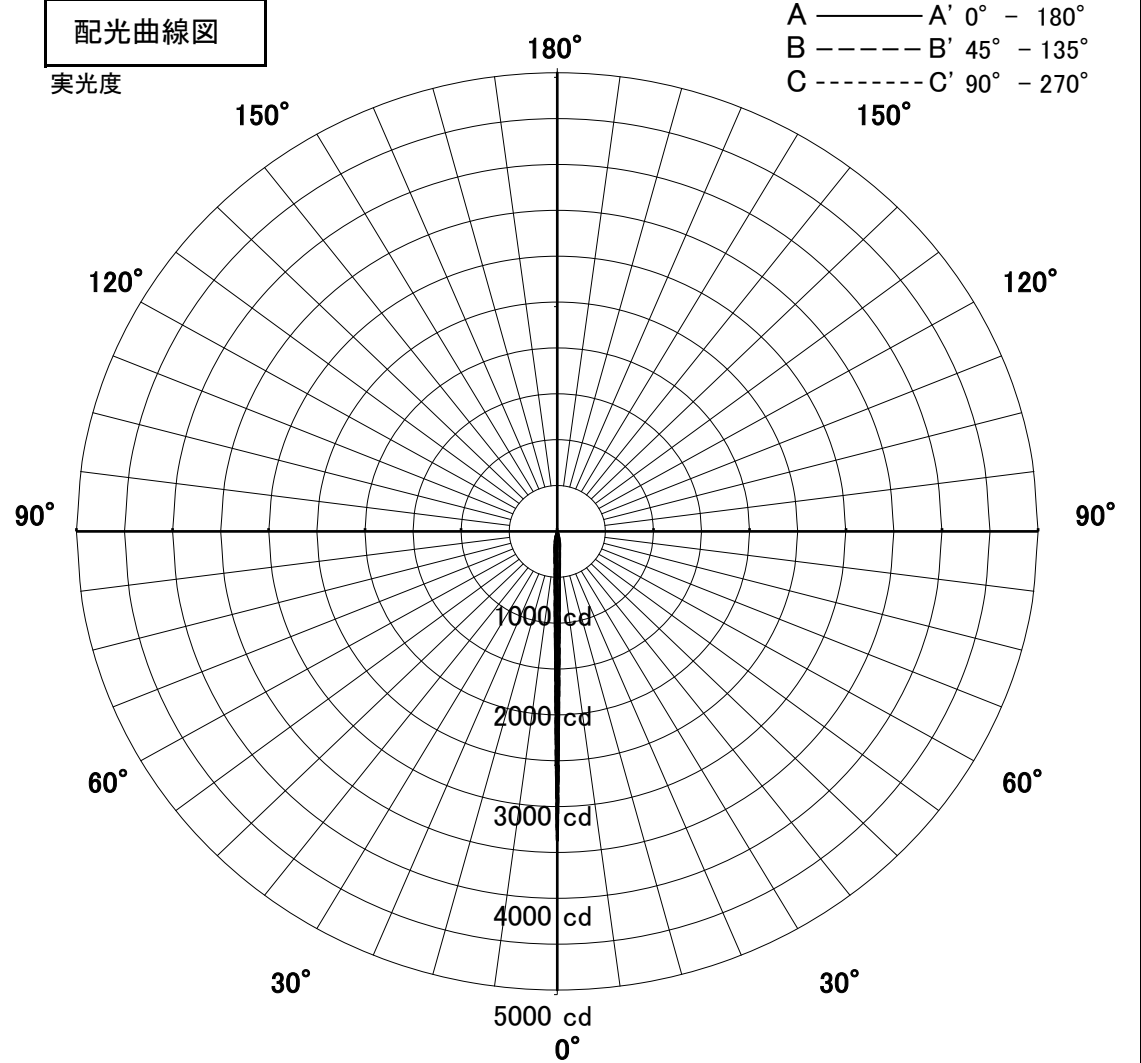

1/2照度角

直射水平面照度

単位: Lx

器具効率	11.8%	
色温度	5000K	
演色評価指数	Ra83	
保守率	良	0.67
	中	0.63
	否	0.56
1/2照度角		
A-A'	10.0	Deg
C-C'	10.0	Deg
最大取付間隔		
A-A'	0.17	H
C-C'	0.17	H

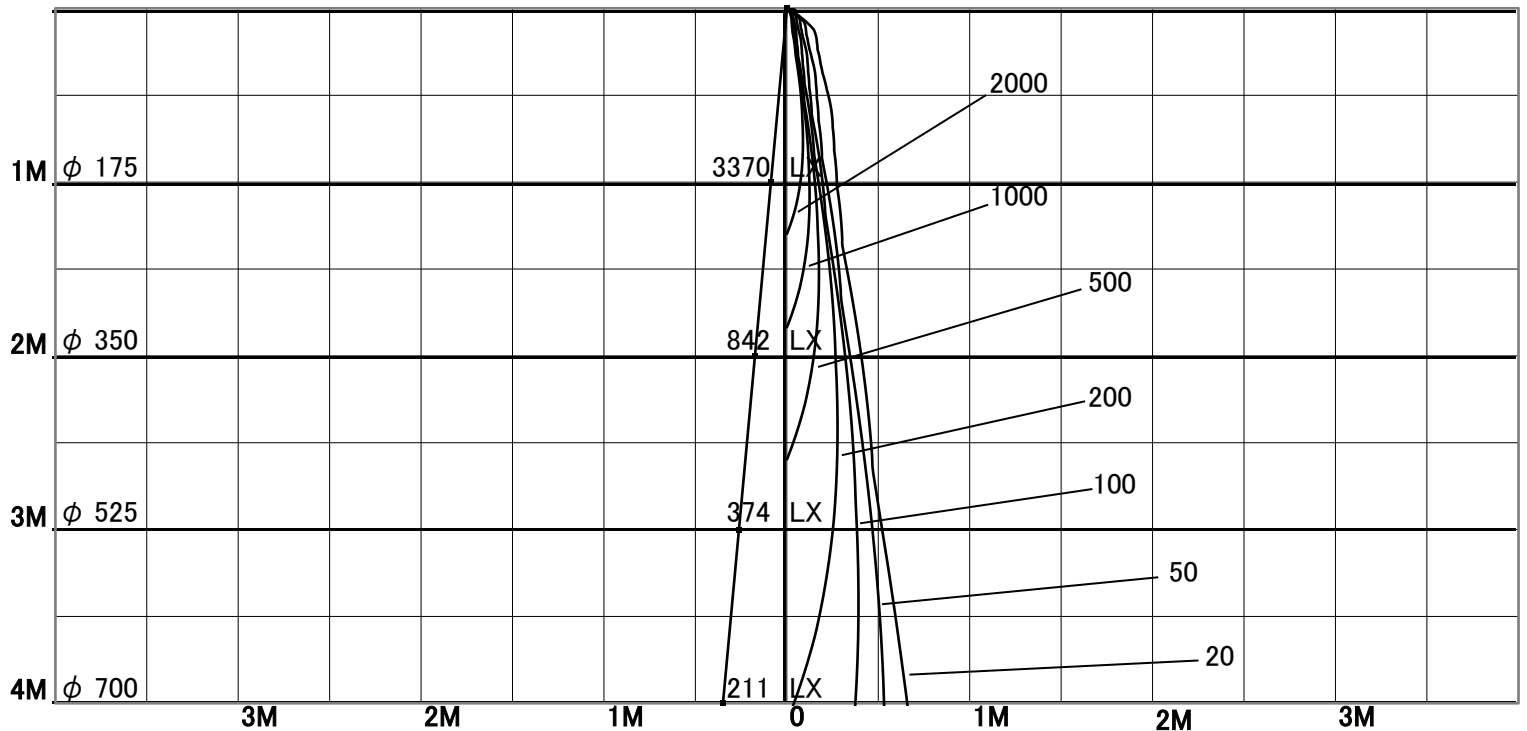

固有照明率表

天井	80%				70%				50%				30%				0%
	70%	50%	30%	10%	70%	50%	30%	10%	70%	50%	30%	10%	70%	50%	30%	10%	0%
壁	10%																0%
床	10%																0%
0.60	28	26	25	24	28	26	25	24	27	26	25	24	27	26	25	24	23
0.80	30	28	27	26	29	28	27	26	29	27	26	26	28	27	26	25	25
1.00	31	29	28	27	31	29	28	27	30	29	28	27	30	29	28	27	27
1.25	32	31	30	29	32	31	30	29	31	30	29	29	31	30	29	28	28
1.50	33	32	31	30	33	31	30	30	32	31	30	30	31	31	30	29	29
2.00	34	33	32	32	34	33	32	31	33	32	32	31	32	32	31	31	30
2.50	35	34	33	33	34	34	33	33	34	33	33	32	33	33	32	32	31
3.00	35	35	34	34	35	34	34	33	34	34	33	33	34	33	33	33	32
4.00	35	35	35	34	35	35	34	34	34	34	34	34	34	34	33	33	33
5.00	36	35	35	35	35	35	35	35	35	35	34	34	34	34	34	34	33
7.00	36	36	36	36	36	36	35	35	35	35	35	35	34	34	34	34	33
10.00	36	36	36	36	36	36	36	36	35	35	35	35	34	34	34	34	34