

屋内照明器具特性

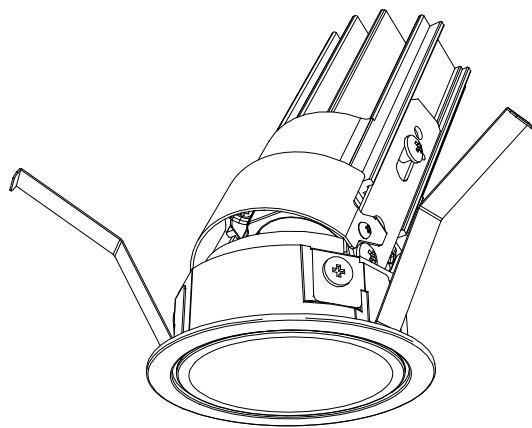

品名	DD-3579-N		
光源	LED10.3W		
実効光束 (器具光束)	135lm	エネルギー 効率	13.1lm/W



配光曲線図
実光度

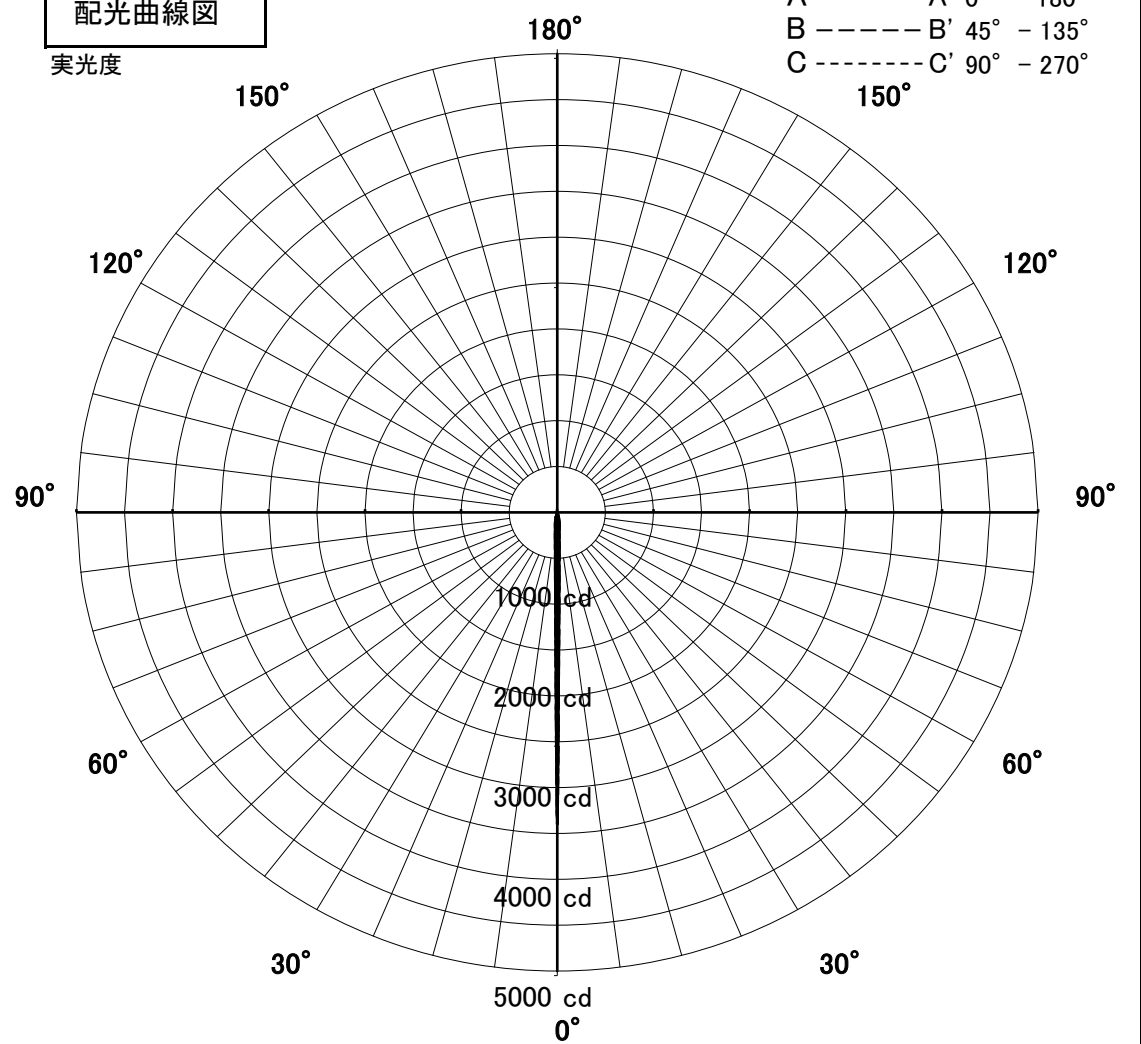

1/2照度角

直射水平面照度

単位: Lx

器具効率	12.3%	
色温度	5000K	
演色評価指数	Ra83	
保守率	良	0.67
	中	0.63
	否	0.56
1/2照度角		
A-A'	10.0	Deg
C-C'	10.0	Deg
最大取付間隔		
A-A'	0.17	H
C-C'	0.17	H

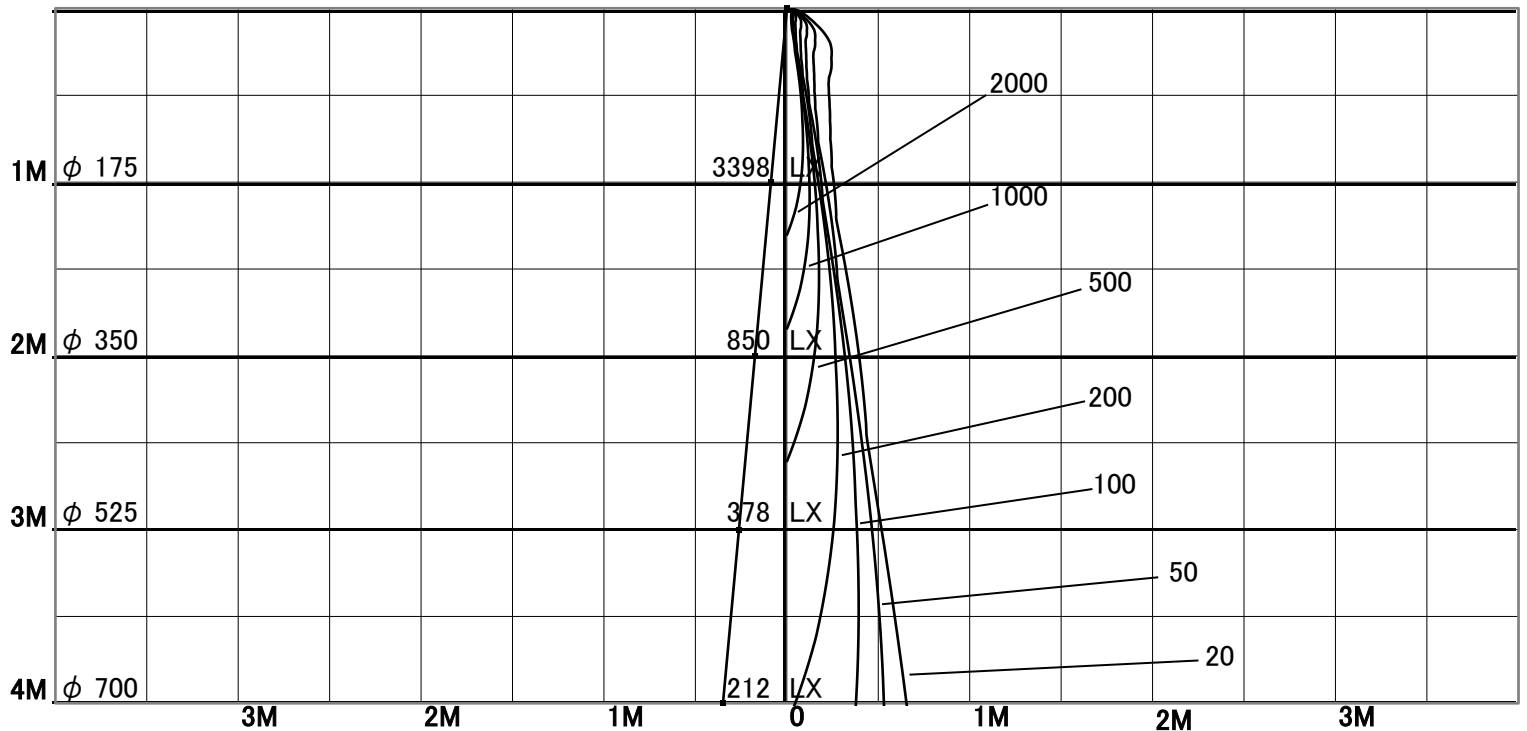

固有照明率表

天井	80%				70%				50%				30%				0%
	70%	50%	30%	10%	70%	50%	30%	10%	70%	50%	30%	10%	70%	50%	30%	10%	0%
壁	10%																0%
床	10%																0%
0.60	26	24	22	21	26	23	22	21	25	23	22	21	25	23	22	21	21
0.80	28	26	24	23	28	25	24	23	27	25	24	23	26	25	24	23	22
1.00	29	27	26	25	29	27	26	25	28	27	26	25	28	27	25	25	24
1.25	31	29	28	27	30	29	27	26	30	28	27	26	29	28	27	26	26
1.50	31	30	29	28	31	30	29	28	30	29	28	27	30	29	28	27	27
2.00	33	31	31	30	32	31	30	30	32	31	30	29	31	30	30	29	28
2.50	33	32	32	31	33	32	31	31	32	32	31	31	32	31	31	30	30
3.00	34	33	33	32	34	33	32	32	33	32	32	31	32	32	31	31	30
4.00	34	34	33	33	34	34	33	33	33	33	33	32	33	32	32	32	31
5.00	35	34	34	34	34	34	34	33	34	33	33	33	33	33	33	32	32
7.00	35	35	35	34	35	34	34	34	34	34	34	33	33	33	33	33	32
10.00	35	35	35	35	35	35	35	34	34	34	34	34	34	33	33	33	32