

屋内照明器具特性

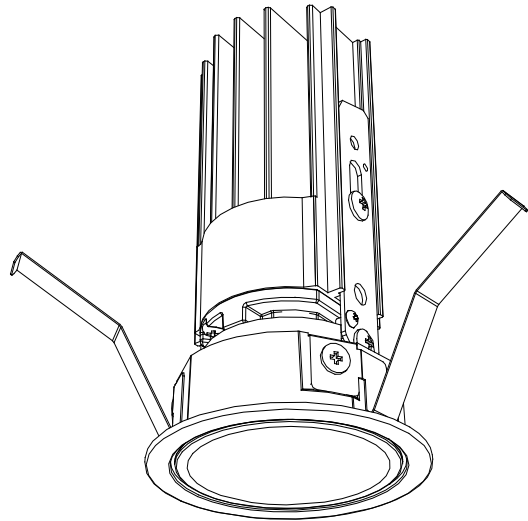

品名	DD-3584-WW		
光源	LED10.3W		
実効光束 (器具光束)	576lm	エネルギー 効率	55.9lm/W



配光曲線図
実光度

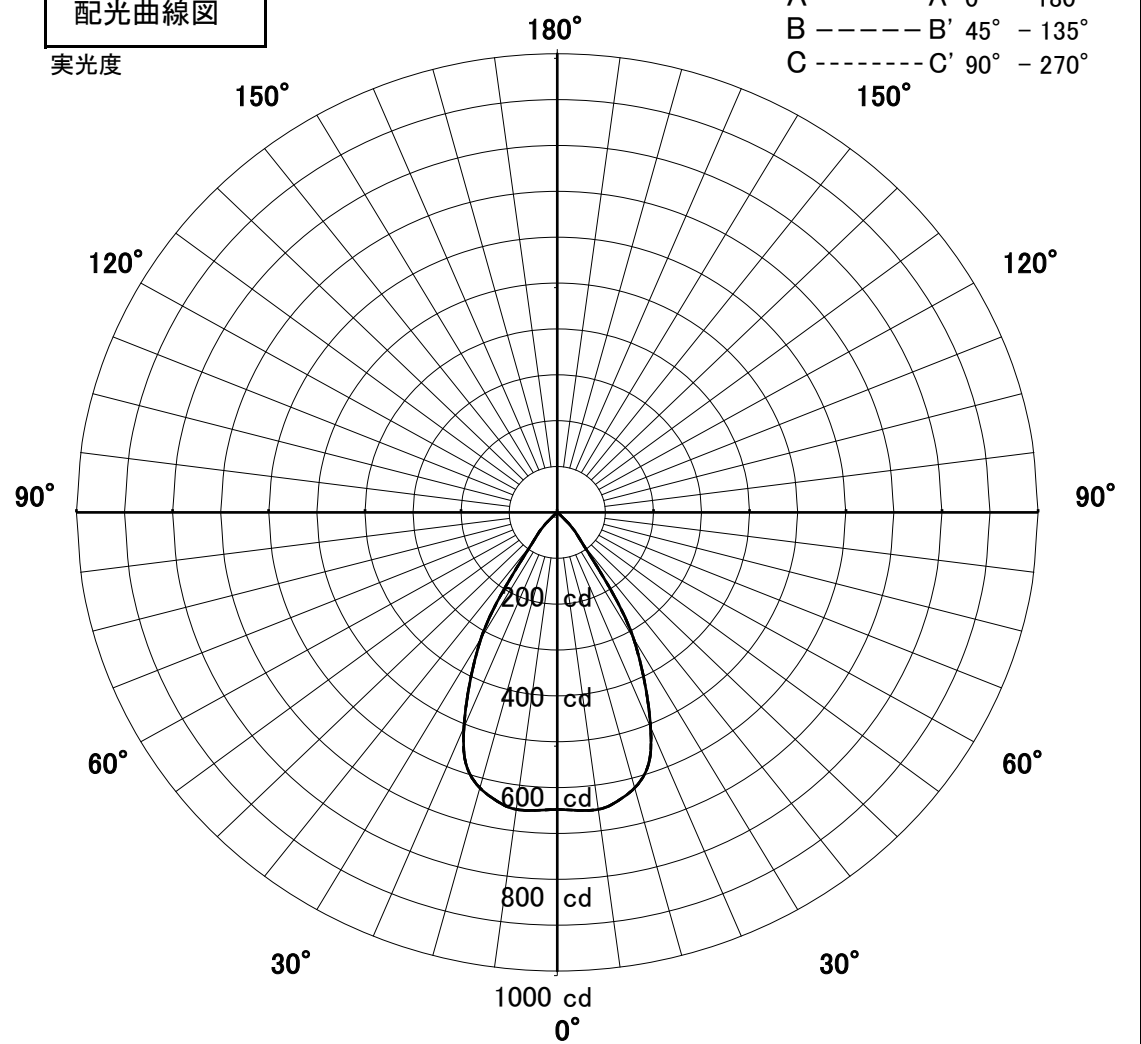

1/2照度角

直射水平面照度

単位: Lx

器具効率	54.3%	
色温度	3500K	
演色評価指数	Ra83	
保守率	良	0.67
	中	0.63
	否	0.56
1/2照度角		
A-A'	51.5	Deg
C-C'	51.5	Deg
最大取付間隔		
A-A'	0.96	H
C-C'	0.96	H

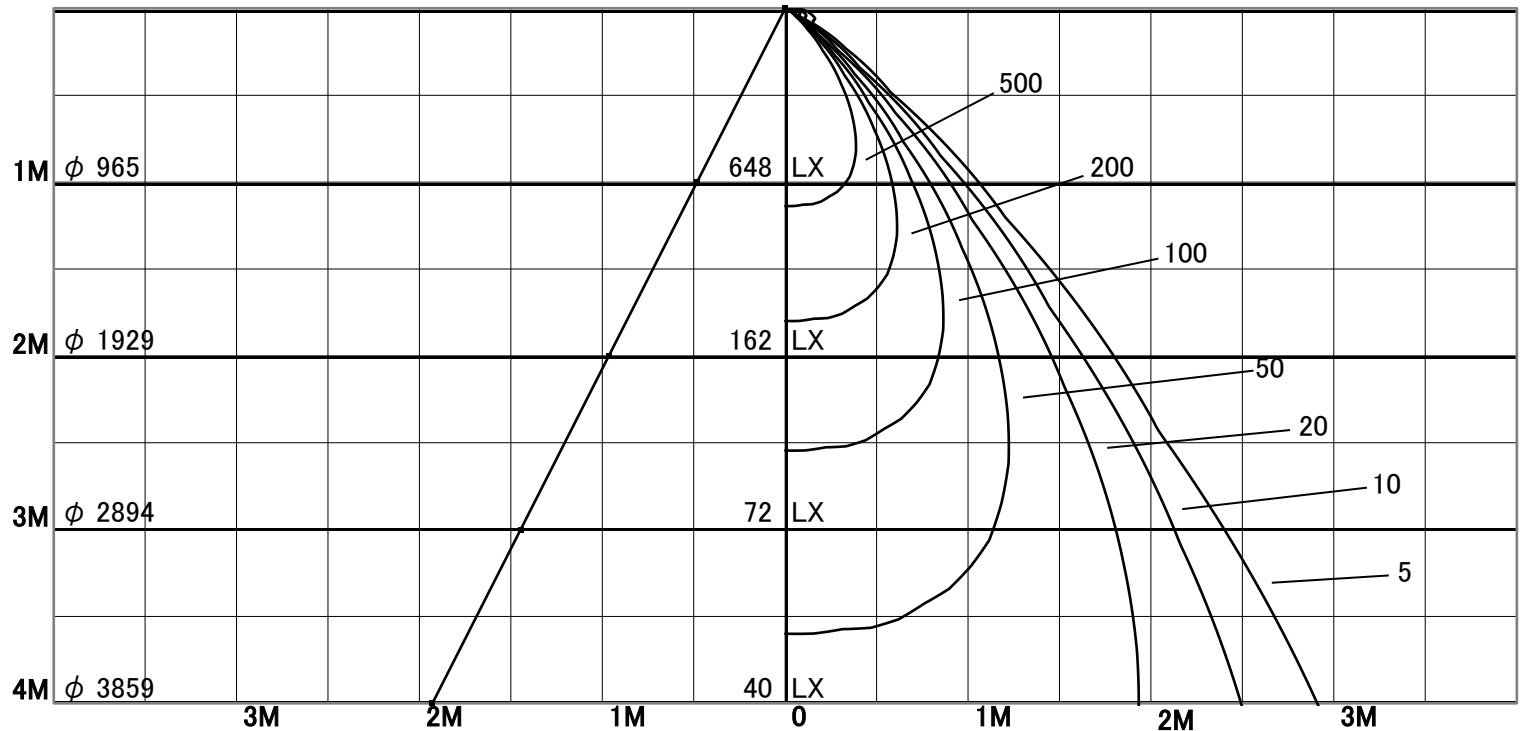

固有照明率表

	80%				70%				50%				30%				0%
	70%	50%	30%	10%	70%	50%	30%	10%	70%	50%	30%	10%	70%	50%	30%	10%	0%
天井	10%																0%
壁	10%																0%
床	10%																0%
0.60	85	79	75	72	84	78	75	72	83	78	74	72	81	77	74	72	71
0.80	90	84	80	77	89	84	80	77	87	83	80	77	86	82	79	77	76
1.00	94	89	85	83	93	88	85	83	91	87	85	82	90	86	84	82	81
1.25	97	93	90	87	96	92	89	87	94	91	88	86	93	90	88	86	84
1.50	99	96	93	90	98	95	92	90	96	94	91	89	95	92	90	89	87
2.00	103	100	98	96	102	99	97	95	100	98	96	94	98	96	95	93	92
2.50	105	102	101	99	104	102	100	99	102	100	99	98	100	99	98	97	95
3.00	106	104	103	102	105	103	102	101	103	102	101	100	101	100	100	99	97
4.00	107	106	105	104	106	105	104	103	104	103	103	102	102	102	101	101	99
5.00	108	107	106	106	107	106	105	105	105	104	104	103	103	103	102	102	100
7.00	109	108	108	107	107	107	107	107	106	105	105	105	104	104	103	103	101
10.00	109	109	109	109	108	108	108	108	106	106	106	106	104	104	104	104	101