

屋内照明器具特性

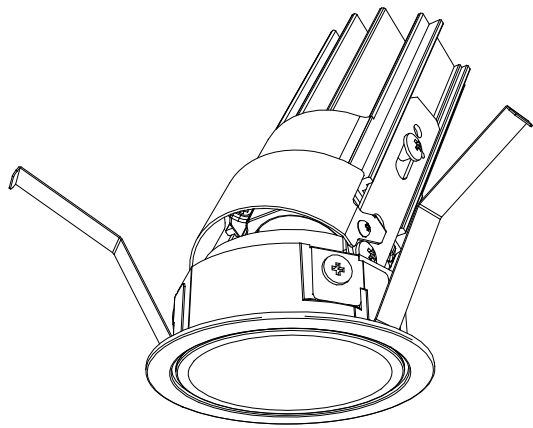

品名	DD-3586-WW		
光源	LED10.3W		
実効光束 (器具光束)	521lm	エネルギー 効率	50.5lm/W



配光曲線図
実光度

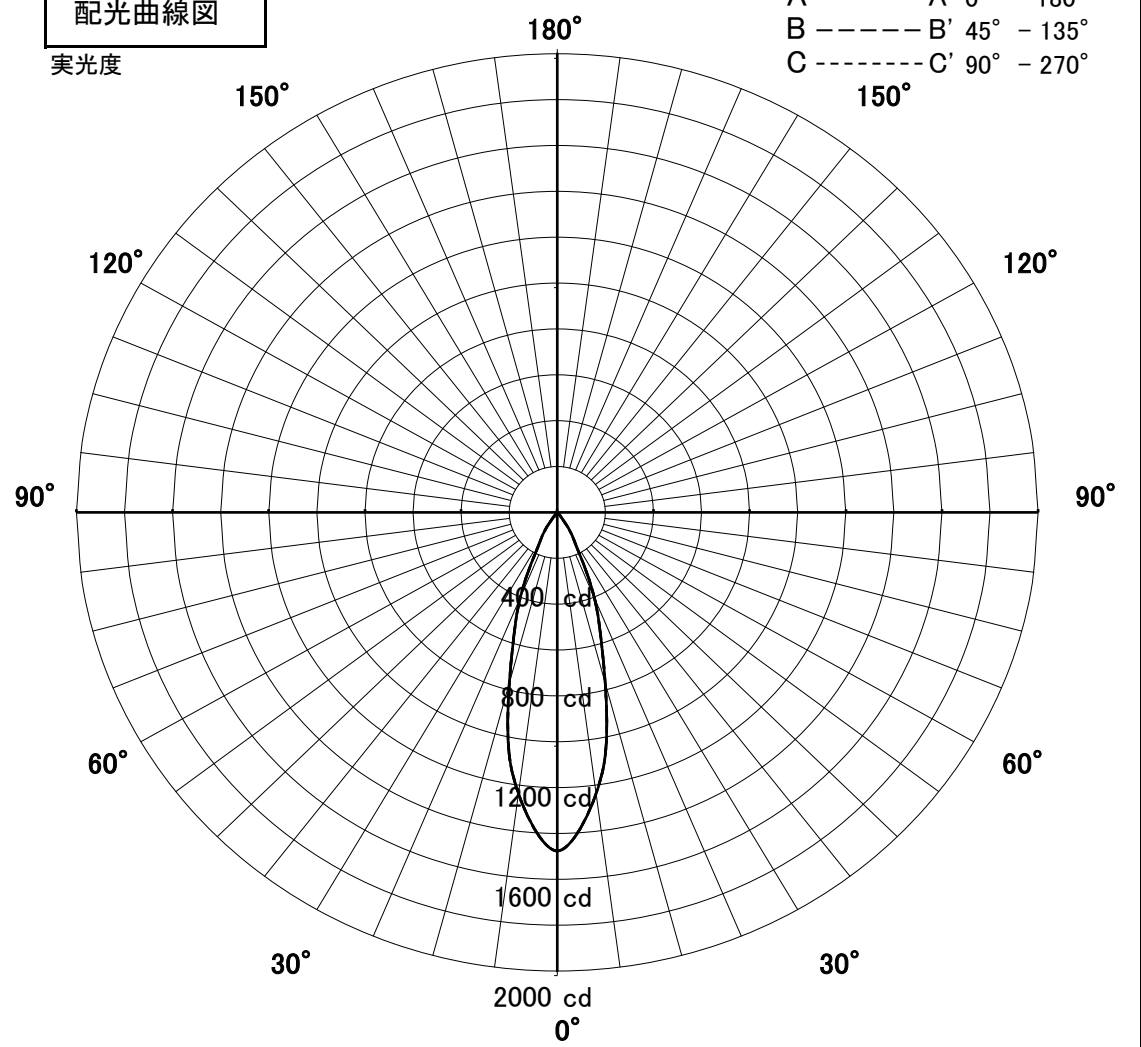

1/2照度角

直射水平面照度

単位: Lx

器具効率	49.2%	
色温度	3500K	
演色評価指数	Ra83	
保守率	良	0.67
	中	0.63
	否	0.56
1/2照度角		
A-A'	29.5	Deg
C-C'	29.5	Deg
最大取付間隔		
A-A'	0.53	H
C-C'	0.53	H

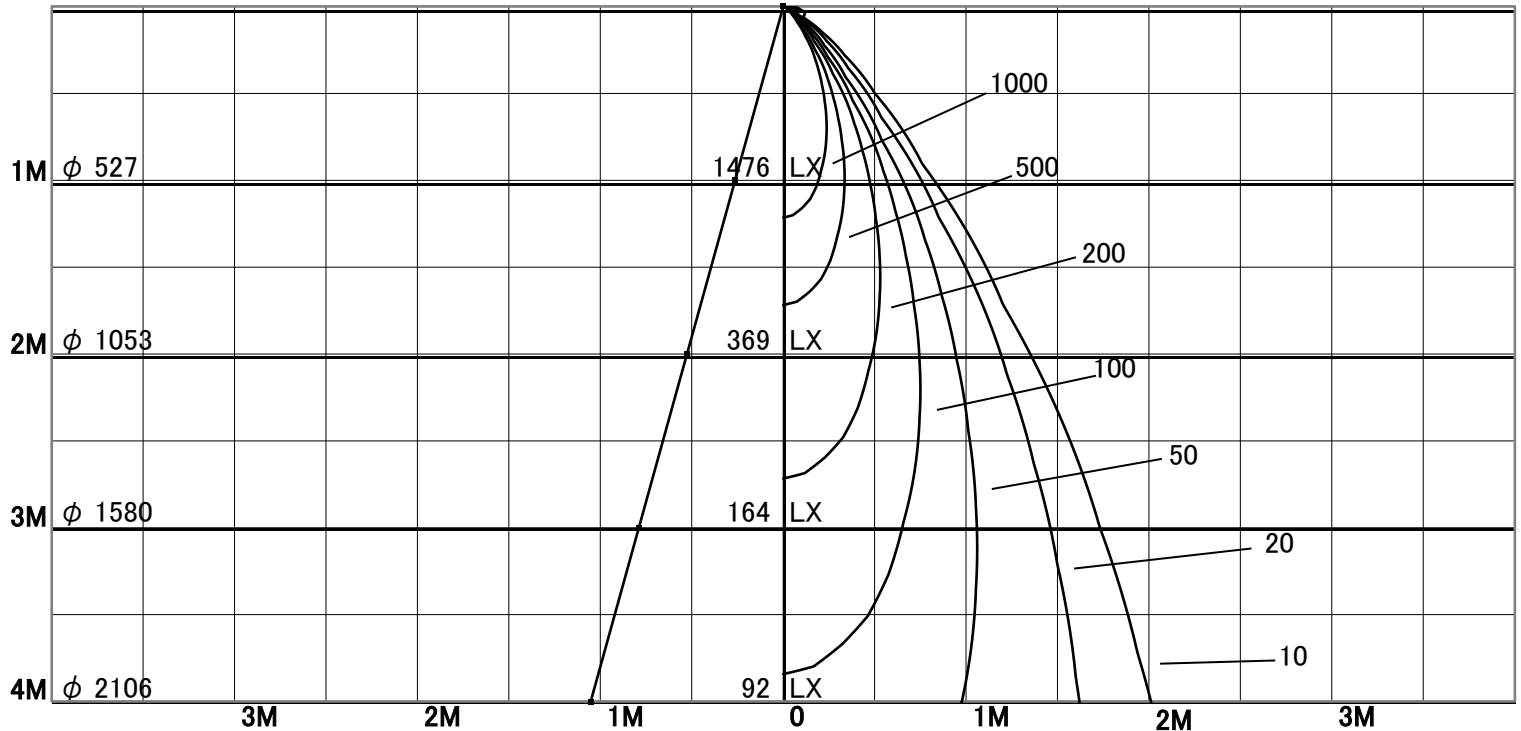

固有照明率表

	80%				70%				50%				30%				0%
	70%	50%	30%	10%	70%	50%	30%	10%	70%	50%	30%	10%	70%	50%	30%	10%	0%
天井	10%																0%
壁	10%																0%
床	10%																0%
0.60	87	82	78	75	87	81	78	75	86	81	78	75	84	80	77	75	74
0.80	92	87	83	80	91	86	83	80	90	86	82	80	89	85	82	80	79
1.00	96	92	88	86	95	91	88	85	94	90	87	85	92	89	87	85	83
1.25	99	95	92	90	98	95	92	89	97	93	91	89	95	92	90	88	87
1.50	101	98	95	93	100	97	94	92	99	96	94	92	97	95	93	91	90
2.00	105	102	100	98	104	101	99	97	102	100	98	97	100	98	97	96	94
2.50	106	105	103	101	106	104	102	101	104	102	101	100	102	101	100	99	97
3.00	108	106	105	104	107	106	104	103	105	104	103	102	103	102	102	101	99
4.00	109	108	107	106	108	107	106	106	106	105	105	104	104	104	103	103	101
5.00	110	109	108	108	109	108	108	107	107	106	106	105	105	105	104	104	102
7.00	110	110	110	110	109	109	109	109	107	107	107	107	106	106	105	105	103
10.00	111	111	111	111	110	110	110	110	108	108	108	108	106	106	106	106	104