

屋内照明器具特性

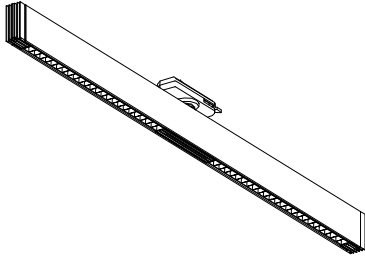

品名	LD-5344-W		
光源	LED22.0W		
実効光束 (器具光束)	1984lm	効率	90.1lm/W



配光曲線図

実光度

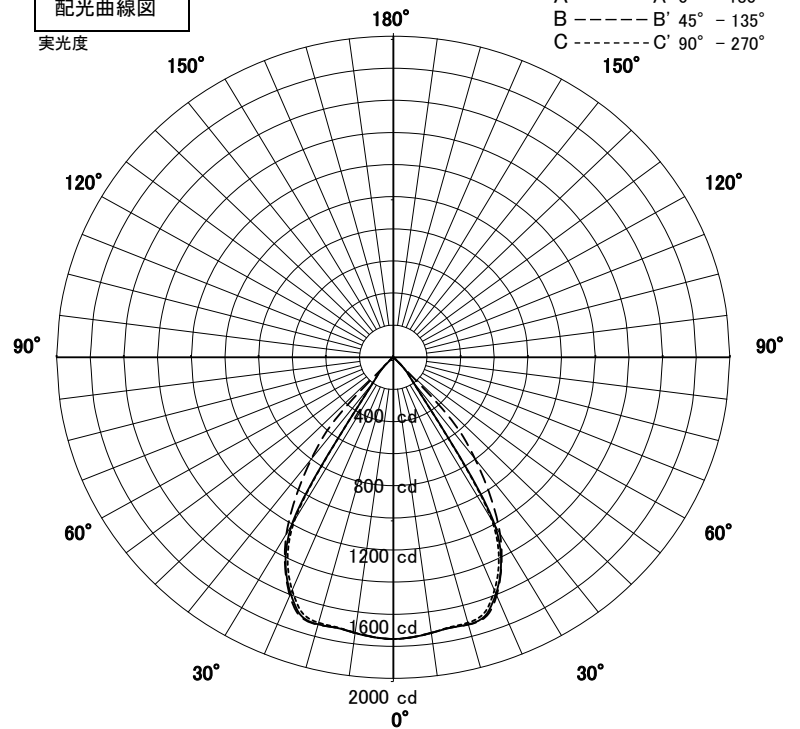

1/2照度角

直射水平面照度

単位:Lx

色温度	4000K	
演色評価指数	Ra90	
保守率	良	0.67
	中	0.63
	否	0.56

1/2照度角		
A-A'	57.5	Deg
C-C'	57.0	Deg
最大取付間隔		
A-A'	1.10	H
C-C'	1.09	H

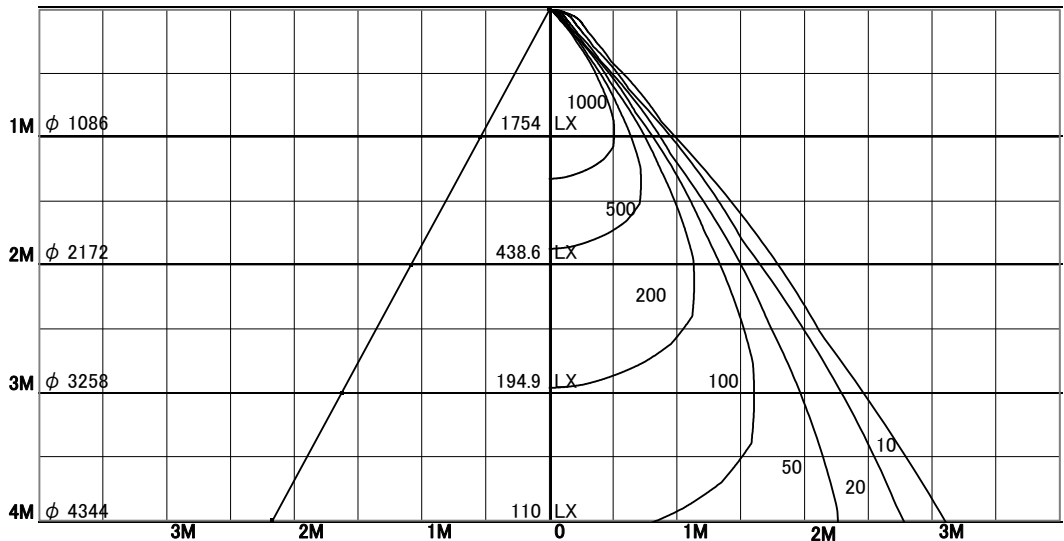

照明率表

天井	80%				70%				50%				30%				0%
	70%	50%	30%	10%	70%	50%	30%	10%	70%	50%	30%	10%	70%	50%	30%	10%	
壁	10%																0%
床	10%																0%
0.60	82	76	72	69	82	76	72	69	80	75	71	69	79	74	71	69	68
0.80	88	82	78	75	87	81	78	75	85	81	77	75	84	80	77	74	73
1.00	92	87	83	81	91	86	83	80	89	85	82	80	88	84	82	80	78
1.25	95	91	88	85	94	90	87	85	93	89	86	84	91	88	86	84	82
1.50	98	94	91	88	97	93	90	88	95	92	89	87	93	91	89	87	85
2.00	101	98	96	94	100	97	95	94	98	96	94	93	97	95	93	92	90
2.50	103	101	99	98	102	100	98	97	100	99	97	96	99	97	96	95	93
3.00	104	103	101	100	103	102	101	99	102	100	99	98	100	99	98	97	95
4.00	106	105	103	103	105	104	103	102	103	102	101	100	101	100	100	99	97
5.00	106	106	105	104	105	105	104	103	103	103	102	102	102	101	101	100	98
7.00	107	107	106	106	106	106	105	105	104	104	104	103	102	102	102	102	99
10.00	108	107	107	107	107	106	106	106	105	105	104	104	103	103	103	102	100