

屋内照明器具特性

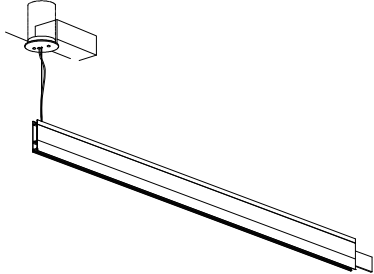

品名	PD-2681-WW		
光源	LED60W		
実効光束 (器具光束)	3901lm	効率	65.0lm/W



配光曲線図
実光度

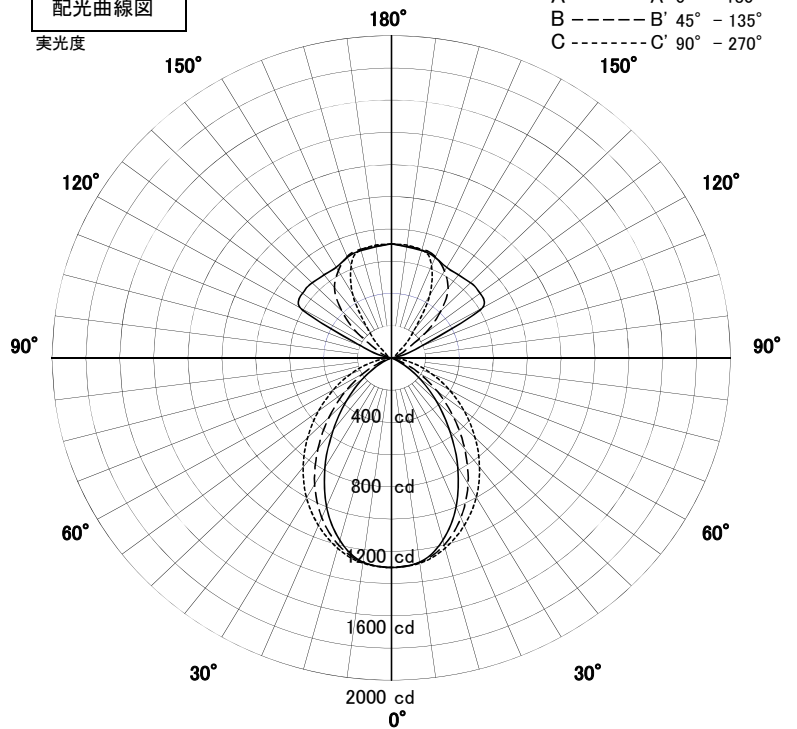

直射水平面照度

単位: Lx

A-A' Section

C-C' Section

色温度	3500K	
演色評価指数	Ra83	
保守率	良	0.63
	中	0.60
	否	0.56
1/2照度角		
A-A'	52.0	Deg
C-C'	60.0	Deg
最大取付間隔		
A-A'	0.98	H
C-C'	1.15	H

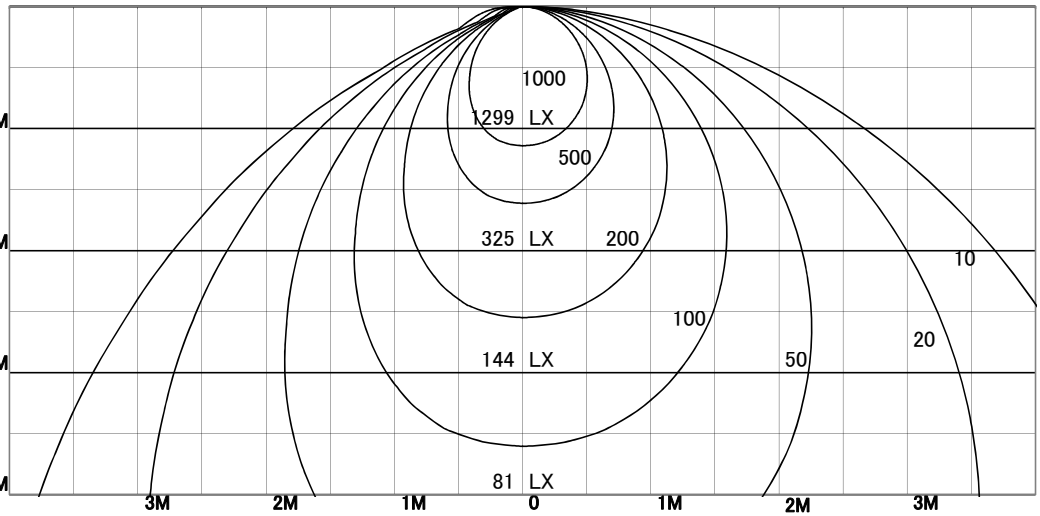

照明率表

	80%				70%				50%				30%				0%
	70%	50%	30%	10%	70%	50%	30%	10%	70%	50%	30%	10%	70%	50%	30%	10%	0%
天井																	
壁																	
床		10%				10%				10%				10%			0%
0.60	39	33	29	26	38	33	29	26	37	32	29	26	36	32	28	26	25
0.80	44	38	35	32	43	38	34	32	42	37	34	32	41	37	34	31	30
1.00	48	43	39	36	47	42	39	36	46	41	38	36	44	41	38	36	35
1.25	51	47	43	40	50	46	43	40	49	45	42	40	47	44	42	40	39
1.50	53	49	46	44	53	49	46	43	51	48	45	43	50	47	45	43	42
2.00	56	53	51	48	56	53	50	48	54	52	50	48	53	51	49	47	46
2.50	58	56	53	52	57	55	53	51	56	54	52	51	55	53	51	50	49
3.00	59	57	55	54	59	57	55	53	57	56	54	53	56	54	53	52	51
4.00	61	59	58	56	60	58	57	56	59	57	56	55	57	56	55	54	53
5.00	62	60	59	58	61	60	58	57	59	58	57	56	58	57	56	56	54
7.00	62	61	60	60	62	61	60	59	60	60	59	58	59	58	58	57	56
10.00	63	62	62	61	62	62	61	60	61	60	60	59	60	59	59	58	57